



Indice prodotti / Product list

Camici chirurgia / Surgery Gowns

Confezione camici chirurgici standard - Standard surgery box gown
Confezione standard camici per chirurgia (in doppia busta) - Standard surgery box gown (double package)
Camici chirurgici con rinforzo - Reinforced surgery gown
Confezione camici chirurgia totalmente rinforzati - Full reinforced surgery box gown
Confezione camici chirurgici standard per chemoterapica - Chemotherapy standard surgery box gown
Confezioni camici chirurgici rinforzati per chemoterapica - Chemotherapy reinforced surgery box gown

Camici per pazienti e visitatori / Patient examination gowns

Camice per visita paziente pediatrico - Pediatric child patient examination gown
Camice per visita paziente collo a "V" - V neck-short sleeve patient examination gown
Camice medico per visita con colletto e maniche lunghe - Doctor neck-short sleeve patient examination gown
Camice per visita paziente con collo a "V" e maniche lunghe - V neck-long sleeve patient examination gown
Camice per visita paziente a girocollo e maniche lunghe - D neck-long sleeve patient examination gown
Camice visitatore a girocollo e maniche lunghe - D neck-long sleeve visitor gown
Camice visitatore con collo a "V" e maniche lunghe - V neck-long sleeve visitor gown

Pantaloni lunghi e corti / Pants and shorts

Kimono casacca e pantaloni - Kimono shirts and pants
Tuta - Rompers
Tuta con cappuccio - Hooded rompers
Pantaloni corti per endoscopia - Endoscopy shorts
Pantaloni per endoscopia - Endoscopy pants
Pantaloni corti percolonscopia - Colonoscopy shorts
Pantaloni per colonscopia - Colonoscopy pants

Teli / Drapes

Telo piccolo SMS per chirurgia minore - SMS minor surgery drape
Telo per tavolo da esame (bordo orlato) - Examination table drape (stretcher drape)
Telo per tavolo da esame semicircolare - Wheel half examination table drape (stretcher drape)
Telo per tavolo da esame circolare - Full wheel examination table drape (stretcher drape)
Telo per tavolo da strumentario - Tools table drape
Telo per tavolo da strumentario (accoppiato) - Tools table drape (laminated)
Telo di Mayo per tavolo - Mayo table drape
Set lenzuolo "t.n.t." - Non woven sheet set
Federa "t.n.t." - Non woven pillow case

Riutilizzabili / Reusable

Abbigliamento per sala operatoria - Operating room clothes
Camice medico - Doctor gowns
Camice infermiere - Nurse gowns
Camice retroriflettente - Reflector gowns
Camice per personale - Staff gowns
Camici pazienti - Patients gowns
Telo foro piccolo - Minor hole drapes
Tessuti sala operatoria - Operating room fabrics



Indice - Contents

Set chirurgia Generale / General surgery drape sets	2 - 8
Set chirurgia Ortopedica / Orthopaedic surgery drape sets	9 - 16
Set chirurgia Cardiologica / Cardiology surgery drape sets	17 - 21
Set chirurgia Ginecologica / Gynecology surgery drape sets	22 - 27
Set chirurgia Neurologica / Brain surgery drape sets	28 - 31
Set chirurgia Oculistica / Ophthalmology surgery drape sets	32 - 36
Set chirurgia Oncologia / Oncology surgery drape sets	37 - 38
Set chirurgia Urologia / Urology surgery drape sets	39 - 42
Set chirurgia Radiologica / Radiology surgery drape sets	43 - 44
Set chirurgia E.N.T. / E.N.T. surgery drape sets	45 - 47
Set chirurgia Estetica / Aesthetic surgery drape sets	48 - 51
Set chirurgia Dentale / Dental surgery drape sets	52 - 54
Camici / Gowns	55 - 56



Set chirurgia Oftalmica / Ophthalmology surgery drape sets



Contenuto - Content	Size (Cm.)	Qt./Piece
Telo occhio Eye drape	100x130	1
Telo occhio Eye drape	100x150	1
Telo occhio Eye drape	130x130	1
Telo occhio Eye drape	150x150	1

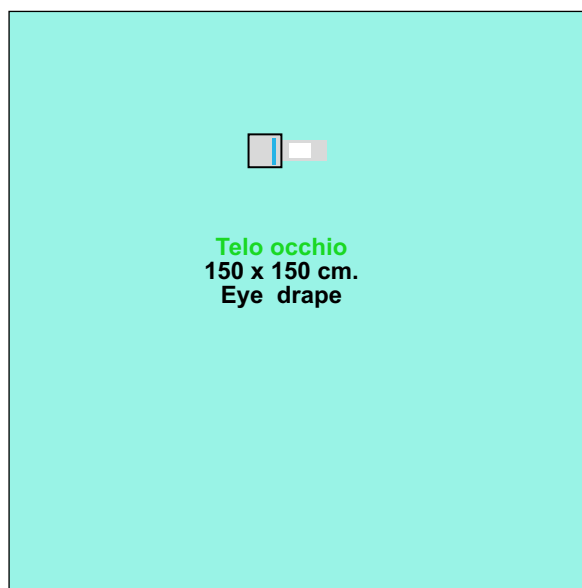
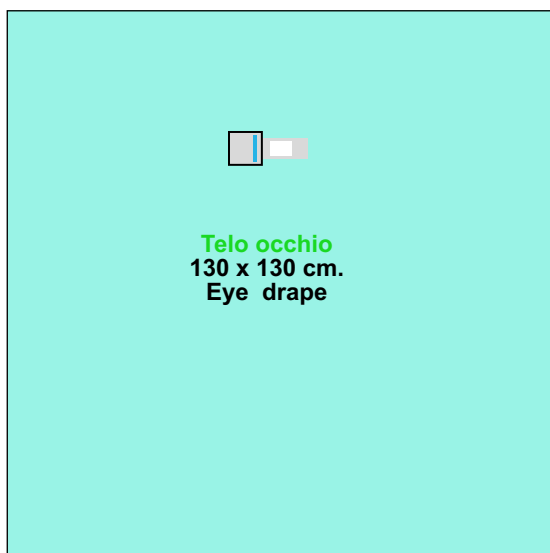
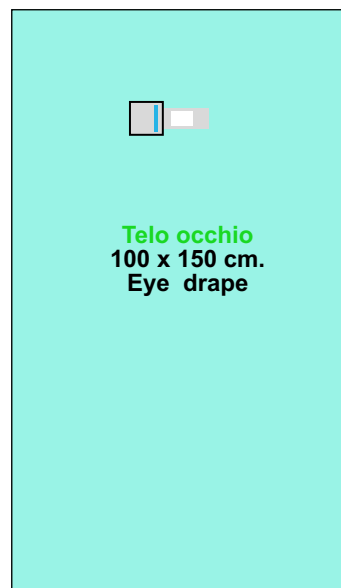

Set Chirurgia generale / General surgery drape sets



Contenuto - Content	Size (Cm.)	Qt./Piece
Telo per anestesia con lato adesivo Anesthesia drape	150x250	1
Telo con adesivo Drape with adhesive tape	150x180	1
Telo con adesivo Drape with adhesive tape	75x100	2
Telo per tavolo strumenti Tools table drape	100x150	1
Telo di mayo per tavolo Mayo table drape	80x150	1
Cerotto OP - tape	10x30	2
Camice chirurgico standard Standard surgery gown	Large	2
Salvietta Towel	40x40	2
Confezione di sterilizzazione Pack of sterilization	100x100	1

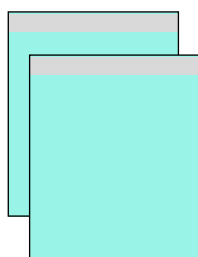

Telo con lato adesivo
75 x 100 cm.
Side taped drape

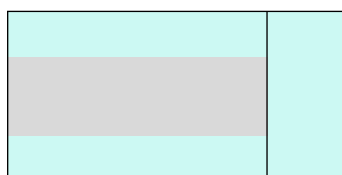

Telo di mayo per tavolo
80 x 150 cm.
Mayo table drape

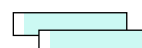

Cerotto
10 x 30 cm.
Op - tape

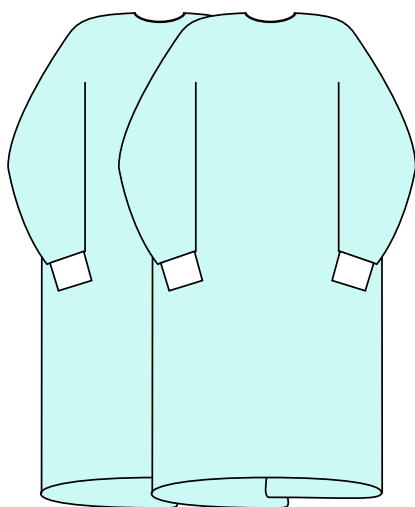

Camice chirurgico standard
Large
Standard surgery gown

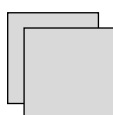

Salvietta
40 x 40 cm.
Towel



Confezione di sterilizzazione
100 x 100 cm.
Pack of sterilizaion



Contenuto - Content	Size (Cm.)	Qt./Piece
Telo occhio Eye drape	100x130	1
Telo occhio Eye drape	100x150	1
Telo occhio Eye drape	130x130	1
Telo occhio Eye drape	150x150	1

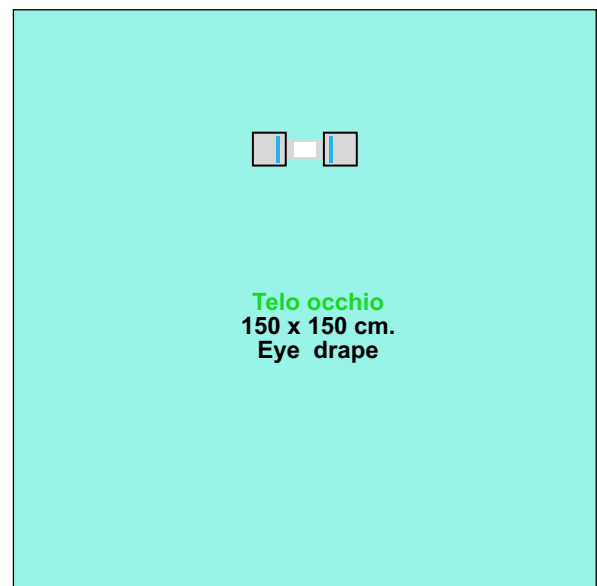
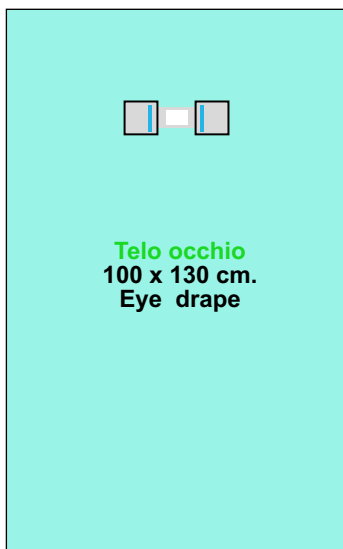

Contenuto - Content	Size (Cm.)	Qt./Piece
Telo occhio Eye drape	100x130	1
Telo Drape	150x180	1
Telo per tavolo strumenti Tools table drape	100x150	1
Camice chirurgico standard Standard surgery gown	Large	2
Salvietta Towel	40x40	2
Confezione di sterilizzazione Pack of sterilization	100x100	1

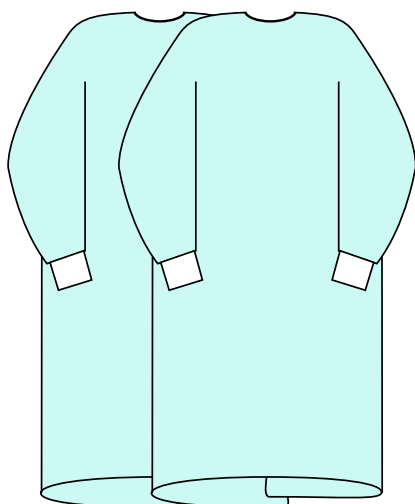
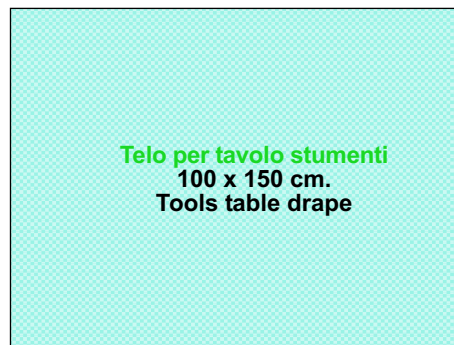

Camice chirurgico standard
Large
Standard surgery gown

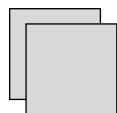

Salvietta
40 x 40 cm.
Towel

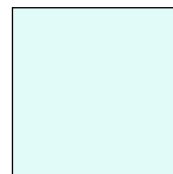

Confezione di sterilizzazione
100 x 100 cm.
Pack of sterilization



Contenuto - Content	Size (cm.)	Qt./Piece
Telo addome Abdominal drape	200x320	1
Telo per tavolo strumenti Tools drape tape	100x150	1
Telo per tavolo strumenti Tools table drape	150x200	1
Telo di mayo per tavolo Mayo table drape	80x150	1
Camice chirurgico standard Standard surgery gown	Large	2
Salvietta Towel	40x40	2
Confezione di sterilizzazione Pack of sterilization	100x100	1

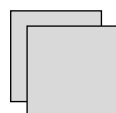
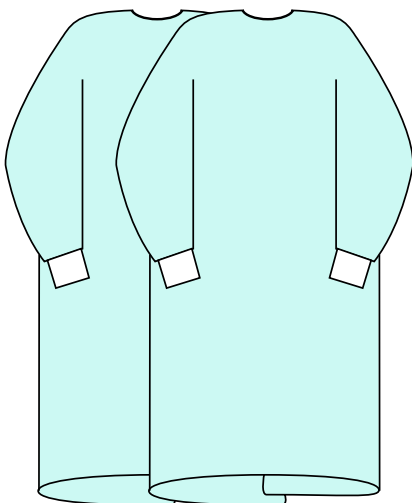
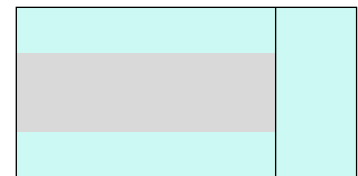
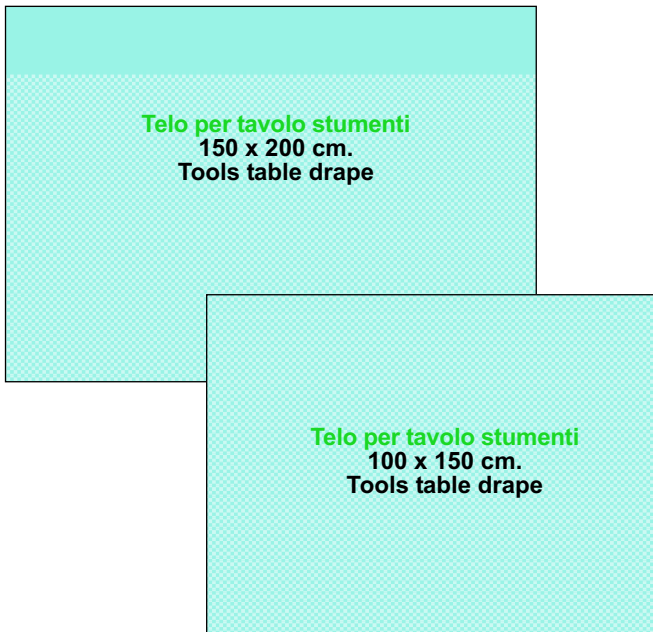
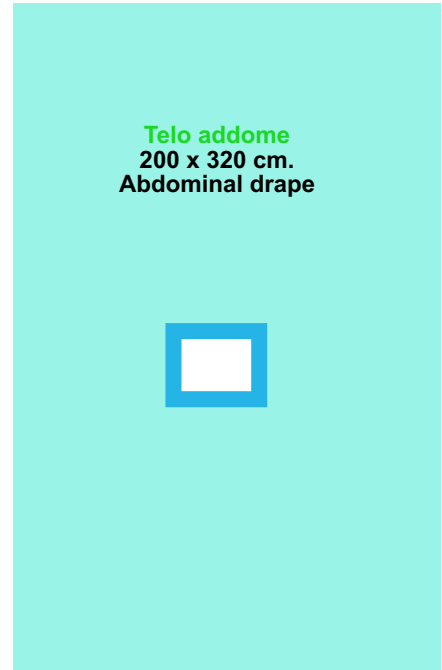

Contenuto - Content	Size (Cm.)	Qt./Piece
Telo laparotomia Laparotomy drape	250x300	1
Telo per tavolo strumenti Tools table drape	100x150	1
Camice chirurgico standard Standard surgery gown	Large	2
Cerotto Op - tape	10x30	2
Salvietta Towel	40x40	2
Confezione di sterilizzazione Pack of sterilization	100x100	1

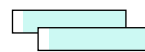
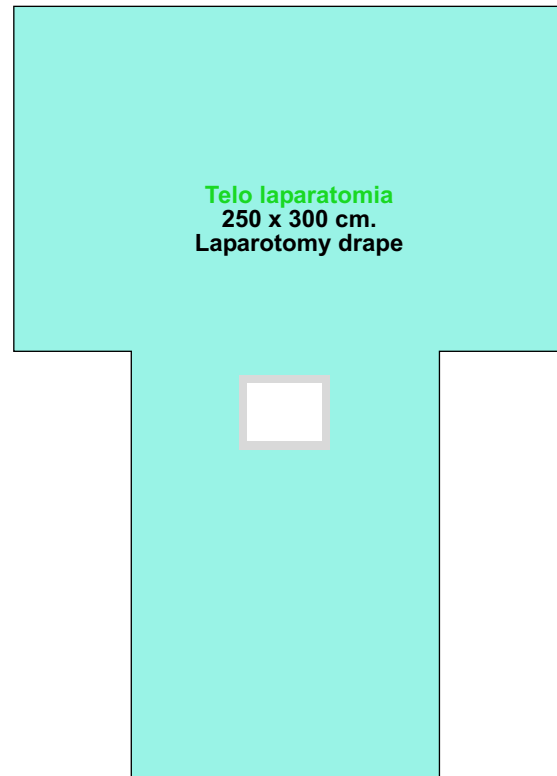

Cerotto
10 x 30 cm.
Op - tape

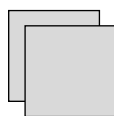

Salvietta
40 x 40 cm.
Towel



Confezione di sterilizzazione
100 x 100 cm.
Pack of sterilizaion

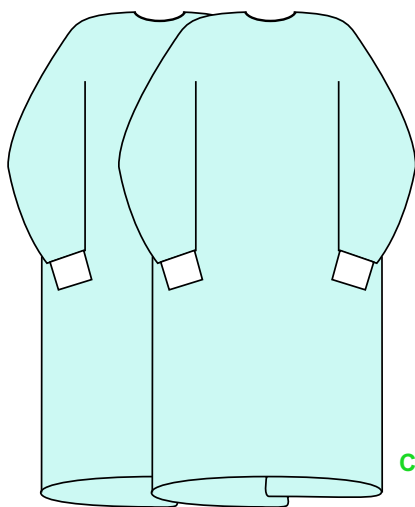

Camice chirurgico standard
Large
Standard surgery gown



Contenuto - Content	Size (Cm.)	Qt./Piece
Sacchetto in PE PE - bag	80x120	1

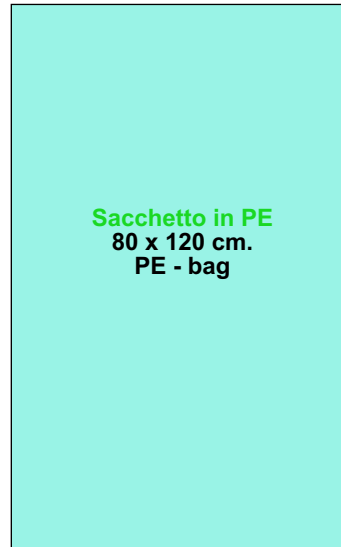

Set chirurgia Oncologica / Oncology surgery drape sets



Contenuto - Content	Size (Cm.)	Qt./Piece
Telo per laparotomia Laparoscopy drape	250x300	1
Telo per tavolo strumenti Tools table drape	150x200	1
Telo di mayo per tavolo Mayo table drape	80x150	1
Camice chirurgico standard Standard surgery gown	large	2
Cerotto Op- tape	10x50	2
Salvietta Towel	40x40	2
Confezione di sterilizzazione Pack of sterilization	100x100	1

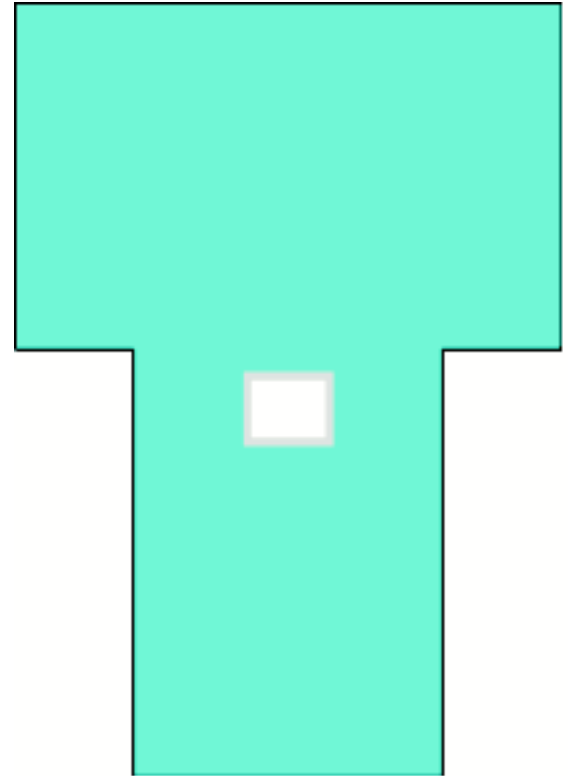

Telo laparoscopia
250 300 cm.
Laparoscopy drape

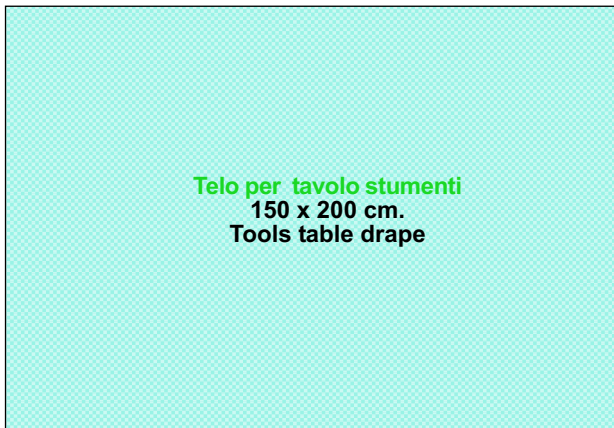

Telo per tavolo stumenti
150 x 200 cm.
Tools table drape

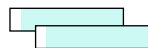

Cerotto
10 x 50 cm.
Op - tape

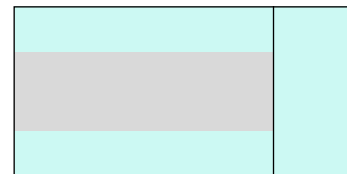

Telo di mayo per tavolo
80 x 150 cm.
Mayo table drape

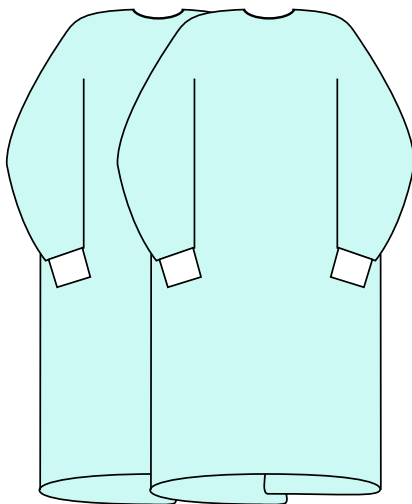

Camice chirurgico standard
Large
Standard surgery gown

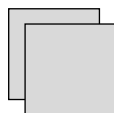

Salvietta
40 x 40 cm.
Towel



Confezione di
sterilizzazione
100 x 100 cm.
Pack of sterilizaion



Contenuto - Content	Size (Cm.)	Qt./Piece
Telo foro minore Minor hole drape	75x75	1
Telo per tavolo strumenti Tools table drape	50x50	1
Camice chirurgico standard Standard surgery gown	Large	1
Salvietta Towel	40x40	1
Confezione di sterilizzazione Pack of sterilization	50x50	1

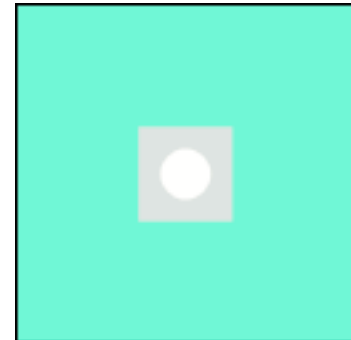

Telo foro minore
75 x 75 cm.
Minor hole drape

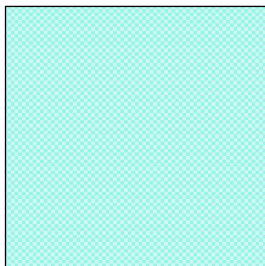

Telo per tavolo strumenti
50 x 50 cm.
Tools table drape

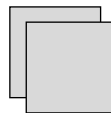

Salvietta
40 x 40 cm.
Towel

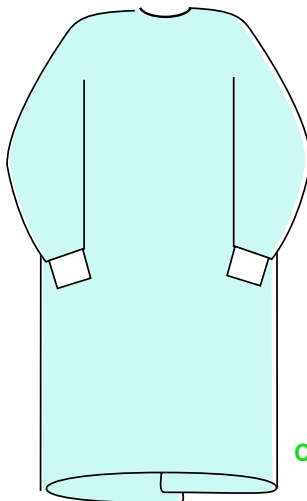

Camice chirurgico standard
Large
Standard surgery gown

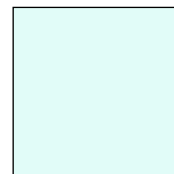

Confezione di sterilizzazione
50 x 50 cm.
Pack of sterilizaion



Contenuto - Content	Size (Cm.)	Qt./Piece
Telo chemioterapia Chemotherapy drape	75x75	1
????? Working footer	40x120	1
Maschera Mask		1
Occhiali di protezione Protection glasses	Paio/pair	1
Cuffia Bonnet		1
Guanti chemioterapici Chemotherapy gloves		1
Camice chirurgico standard Standard surgery gown	Large	2
Salvietta Towel	40x40	2
Confezione di sterilizzazione Pack of sterilization	100x100	1

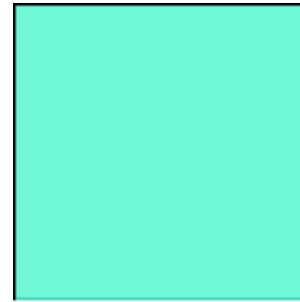

Telo chemioterapia
75 x 75 cm.
Chemotherapy drape

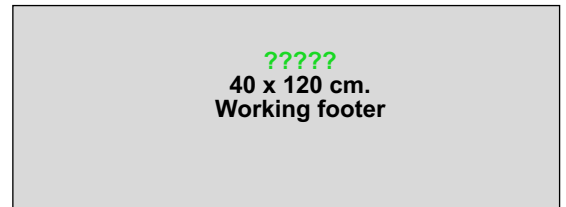

?????
40 x 120 cm.
Working footer

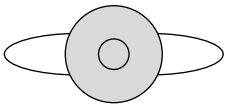

Maschera
Mask

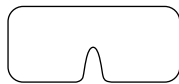

Occhiali protettivi
Protective glasses

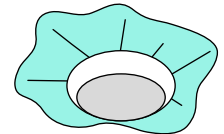

Cuffia
Bonnet

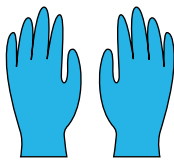

Guanti chemioterapici
Chemotherapy gloves

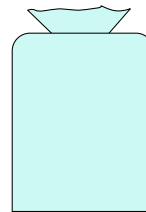

Sacchetto rifiuti
Waste bag

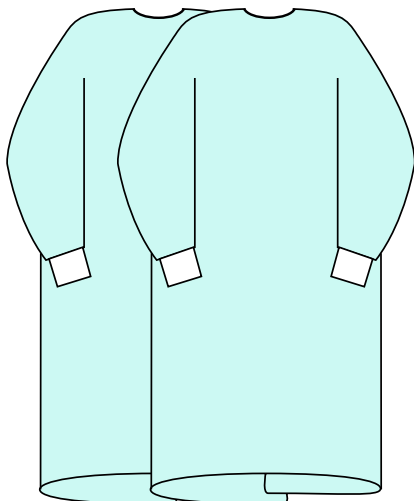

Camice chirurgico standard
Large
Standard surgery gown

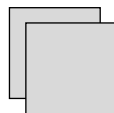

Salvietta
40 x 40 cm.
Towel



Confezione di
sterilizzazione
100 x 100 cm.
Pack of sterilizaion



Set chirurgia Urologica / Urology surgery drape sets



Contenuto - Content	Size (Cm.)	Qt./Piece	
Telo foro con striscia adesiva Drape with adhesive tape	60x60	1	 Telo con foro e lato adesivo 60 x60 cm. Hole drape with adhesive tape
Contenitore per soluzione Solution cup	250 cc.	1	
Spugna betadine Betadine sponge		1	
Sacca universale Universal bag	30x35	1	 Contenitore per soluzione 250 cc. Solution cup
Tamponi Spanch	7,5x7,5	5	
Guanti chirurgici Surgery gloves	large	1	
Salvietta Towel	40x40	1	
Confezione di sterilizzazione Pack of sterilization	50x50	1	 Spugna betadine Betadine sponge

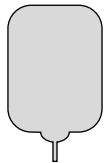

Sacca universale
30 x 50 cm.
Universal torba



Tamponi
7,5 x 7,5 cm.
Spanch

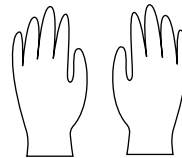

Guanti chirurgici
Large
Surgery gloves

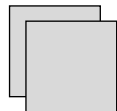

Salvietta
40 x 40 cm.
Towel



Confezione di sterilizzazione
50 x 50 cm.
Pack of sterilizaion

Set chirurgia Ortopedica / Orthopaedic surgery drape sets

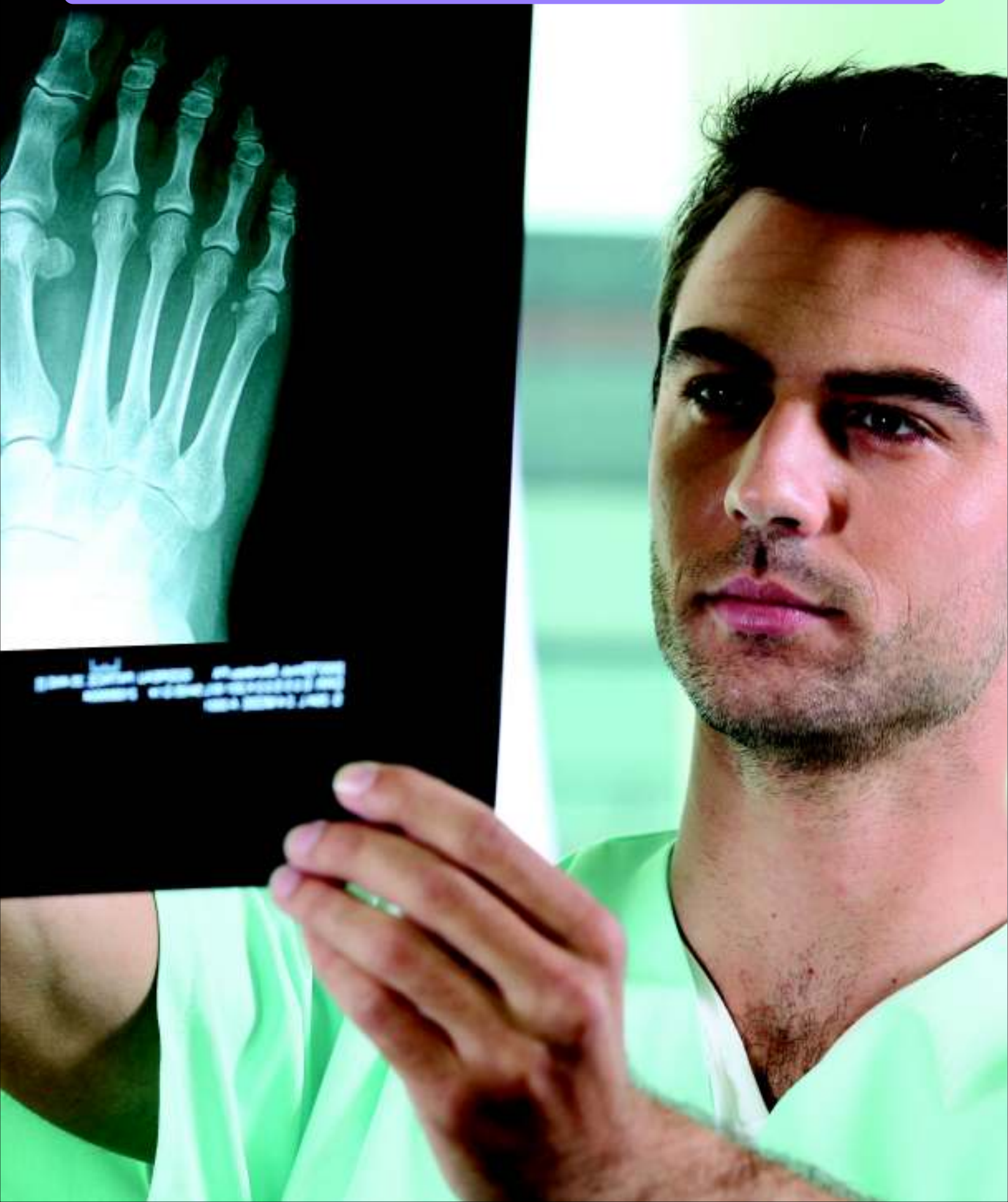

Contenuto - Content	Size (Cm.)	Qt./Piece
Telo percutanea Percutaneous drape	150x300	1
Telo per tavolo strumenti Tools table drape	100x150	1
Cerotto Op - tape	10x50	1
Copertura sonda Scopy cover	50x80	1
Copertura video camera Video camera cover	13x250	1
Camice chirurgico standard Standard surgery gown	large	2
Salvietta Towel	40x40	1
Pack of sterilization	100x100	1

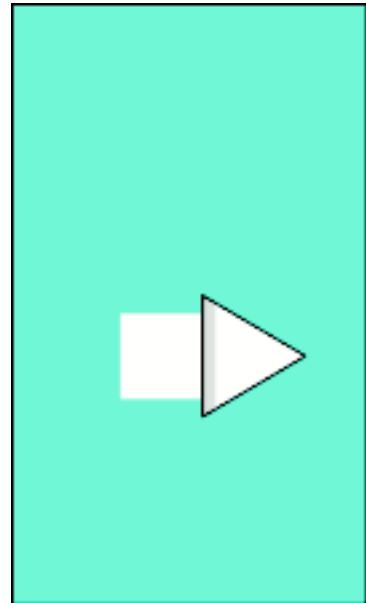

Telo percutanea
150 x 300 cm.
Percutaneous drape



Telo per tavolo strumenti
100 x 150 cm.
Tools table drape

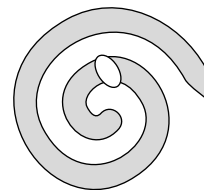

Copertura sonda
50 x 80 cm.
Scopy cover

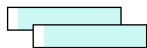

Cerotto
10 x 50 cm.
Op - tape



Copertura per videocamera
30 x 250 cm.
Video camera cover

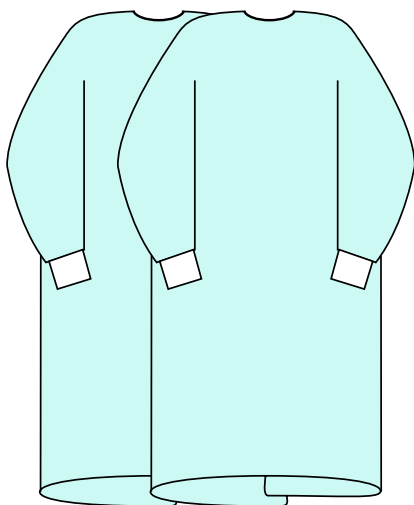

Camice chirurgico standard
Large
Standard surgery gown

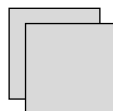

Salvietta
40 x 40 cm.
Towel

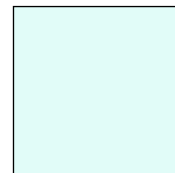

Confezione di sterilizzazione
100 x 100 cm.
Pack of sterilizaion



Contenuto - Content	Size (Cm.)	Qt./Piece
Telo T.U.R. T.U.R. drape	200x240	1
Telo Drape	100x120	1
Telo per tavolo strumenti Tools table drape	150x200	1
Camice chirurgico rinforzato Standard surgery gown	Large	2
Salvietta Towel	40x25	1
Confezione di sterilizzazione Pack of sterilization	100x100	1

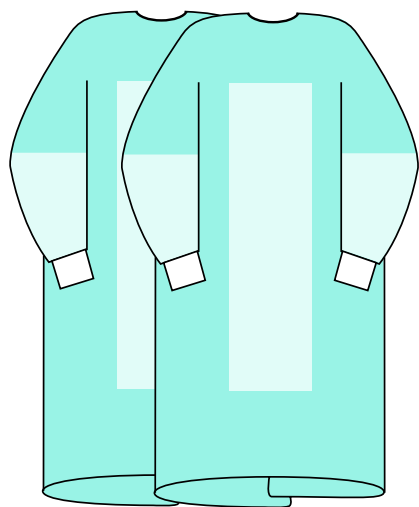
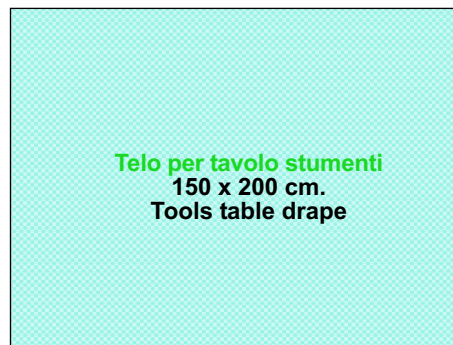
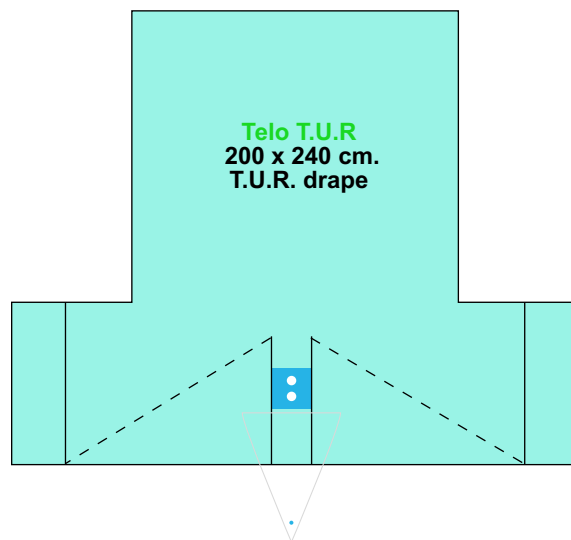

Camice chirurgico rinforzato
Large
Reinforced surgery gown



Salvietta
40 x 25 cm.
Towel



Confezione di sterilizzazione
100 x 100 cm.
Pack of sterilization



Contenuto - Content	Size (Cm.)	Qt./Piece
Telo artroscopia con tasca Arthroscopy drape with pouch	200x300	1
Telo per tavolo strumenti Tools table drape	150x200	1
Stochinette per mano Stockinette (for hand)	40x75	1
Copertura per videocamera Video camera cover	13x250	1
Benda elastico Elastic bandage	10x250	1
Cerotto Op-tape	10x50	2
Matita dermatografica e righello Skin marker & ruller		1
Camice chirurgico rinforzato Reinforced surgery gown	large	2
Salvietta Towel	40x40	2
Confezione di sterilizzazione Pack of sterilization	100x100	1

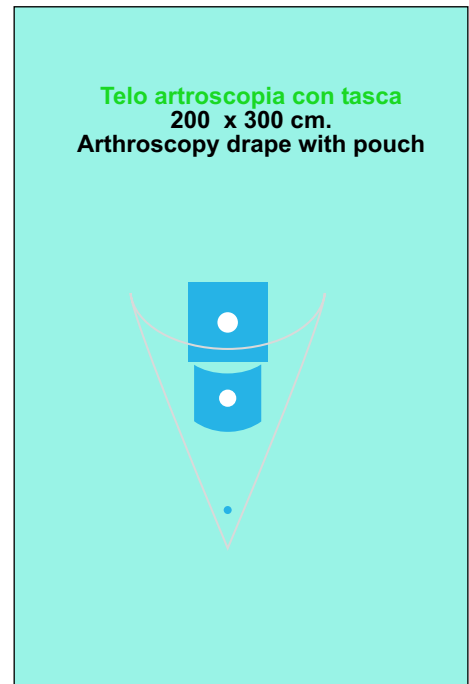

Stochinette per mano
40 x 75 cm.
Stockinette (for hand)



Copertura per videocamera
13 x 250 cm.
Video camera cover



Matita dermatografica e righello
Skin marker & ruller

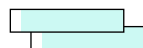

Cerotto
10 x 50 cm.
Op - tape



Benda elastico
10 x 200 cm.
Elastic bandage

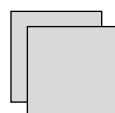

Salvietta
40 x 40 cm.
Towel

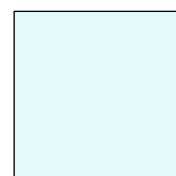

Confezione di sterilizzazione
100 x 100 cm.
Pack of sterilizaion

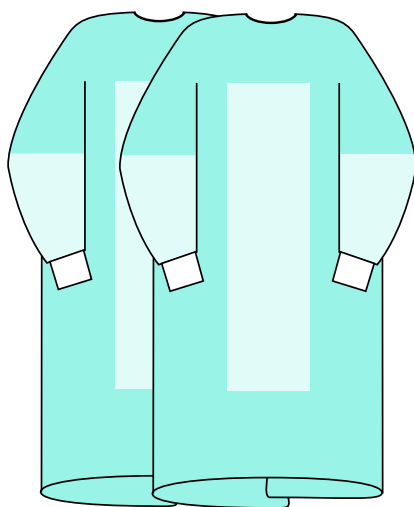

Camice chirurgico rinforzato
Large
Reinforced surgery gown



Contenuto - Content	Size (Cm.)	Qt./Piece
Telo con foro per estremità Extremity drape	200x300	1
Telo con adesivo Drape with adhesive tape	150x180	1
Telo per tavolo strumenti Tools table drape	150x200	1
Telo di mayo per tavolo Mayo table drape	80x150	1
Cerotto Op - tape	10x30	2
Matita dermatografica e righello Marker and ruler		1
Camice chirurgico rinforzato Reinforced surgery gown	Large	2
Salvietta Towel	40x40	2
Confezione di sterilizzazione Pack of sterilization	100x100	1

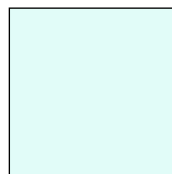
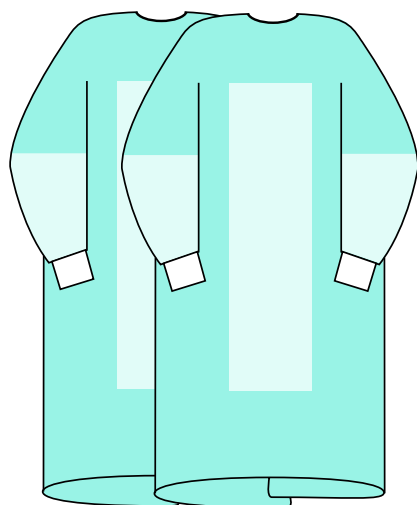
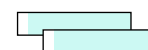
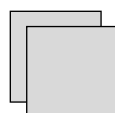
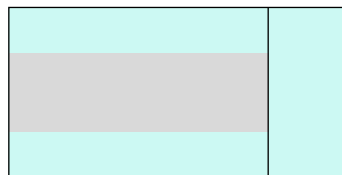

42 Set chirurgia cistoscopia - Cystoscopy drape set

Contenuto - Content	Size (Cm.)	Qt./Piece
Telo cistoscopia Cystoscopy drape	75x150	1
Telo Drape	100x120	1
Telo per tavolo strumenti Tools table drape	100x150	1
Coprigambe Leg cover	60x115	2
Camice chirurgico rinforzato Reinforced surgery gown	Large	2
Salvietta Towel	40x40	2
Confezione di sterilizzazione Pack of sterilization	100x100	1

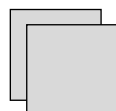
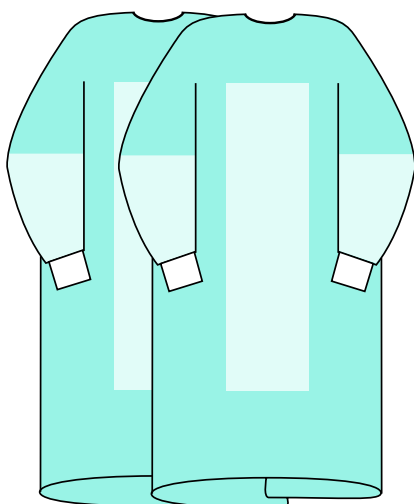
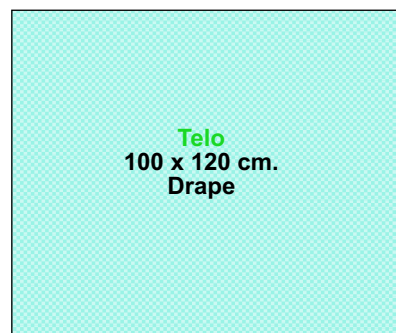
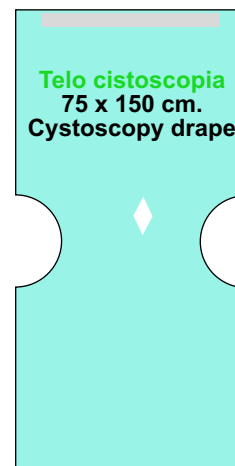

Set chirurgia Radiologica / Radiology surgery drape sets



Contenuto - Content	Size (Cm.)	Qt./Piece
Telo con foro per estremità Extremity drape	200x300	1
Telo per tavolo strumenti Tools table drape	100x150	1
Telo di mayo per tavolo Mayo table drape	80x150	1
Camice chirurgico rinforzato Reinforced surgery gown	Large	2
Confezione di sterilizzazione Pack of sterilization	100x100	1

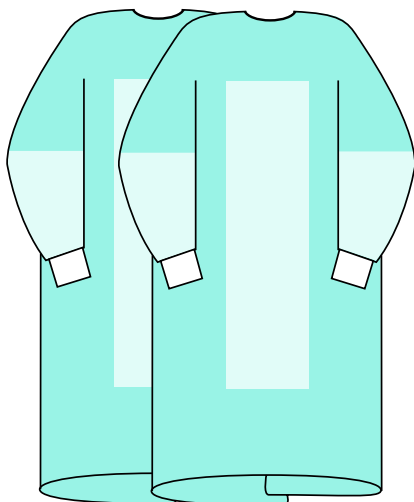
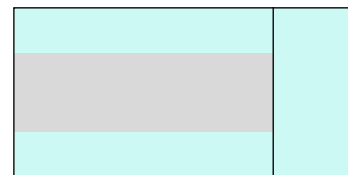

Contenuto - Content	Size (Cm.)	Qt./Piece
Telo con foro per estremità Extremity drape	200x300	1
Telo con adesivo Drape with adhesive tape	75x80	1
Telo per tavolo strumenti Tools table drape	100x150	1
Telo di mayo per tavolo Mayo table drape	80x150	1
Cerotto Op - tape	10x50	2
Camice chirurgico rinforzato Reinforced surgery gown	Large	2
Salvietta Towel	40x40	2
Confezione di sterilizzazione Pack of sterilization	100x100	1

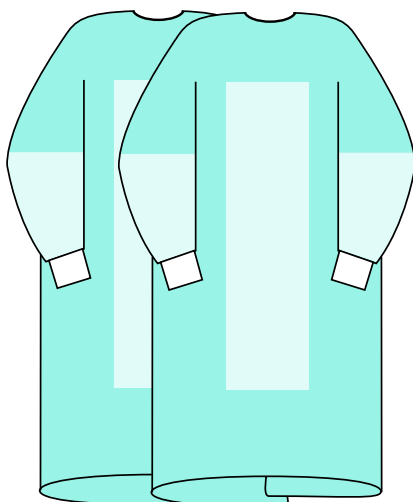
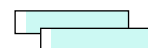
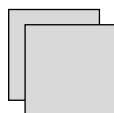
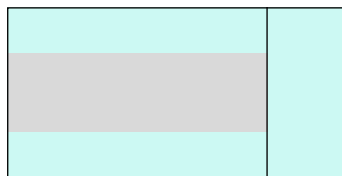

Contenuto - Content	Size (Cm.)	Qt./Piece
Telo anestesia Anesthesia drape	150x300	1
Telo per tavolo strumenti Tools table drape	100x150	1
Camice chirurgico standard Standard surgery gown	Large	2
Salvietta Towel	40x40	2
Confezione di sterilizzazione Pack of sterilization	75x75	1

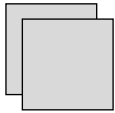
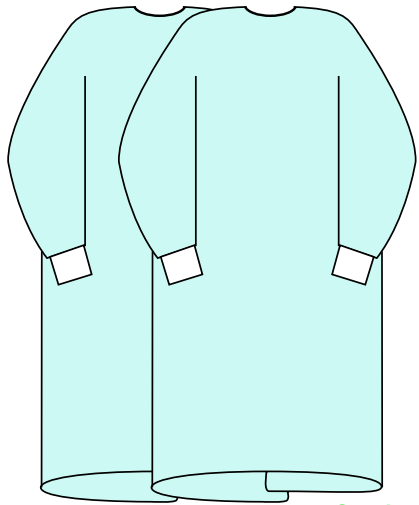
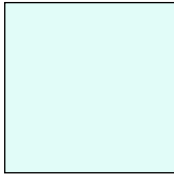
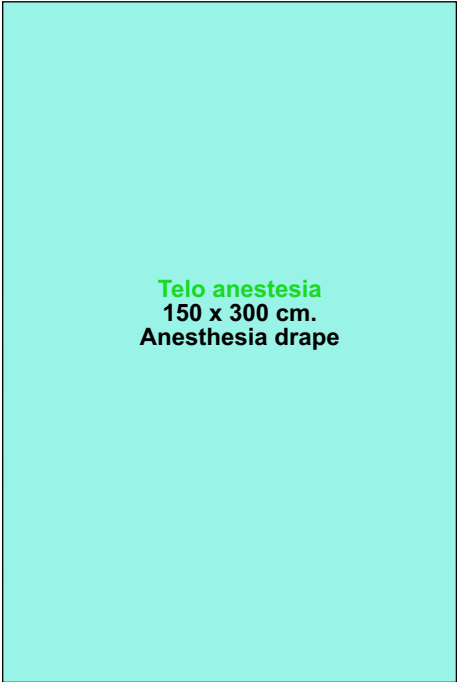

Set chirurgia E.N.T. / E.N.T. surgery drape sets



Contenuto - Content	Size (Cm.)	Qt./Piec
Telo spalla Shoulder drape	200x300	1
Telo con lato adesivo Drape with adhesive tape	75x100	1
Telo per tavolo strumenti Tools table drape	100x150	1
Telo di mayo per tavola Mayo table drape	80x 150	1
Cerotto Op - tape	10x50	2
Camice chirurgico standard Standard surgery gown	Large	2
Salvietta Towel	40x40	2
Confezione di sterilizzazione Pack of sterilization	100x100	1

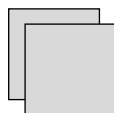
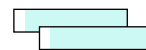
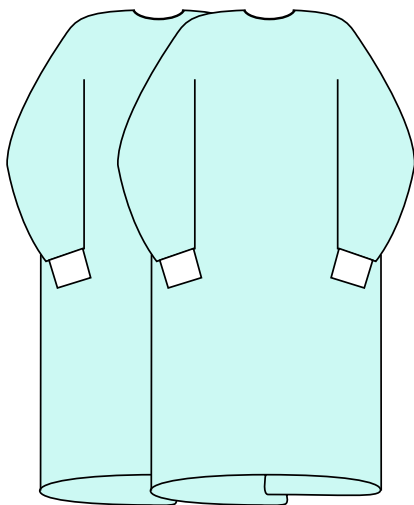
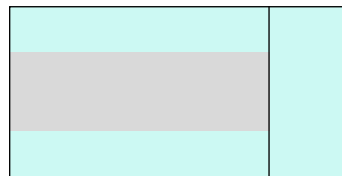
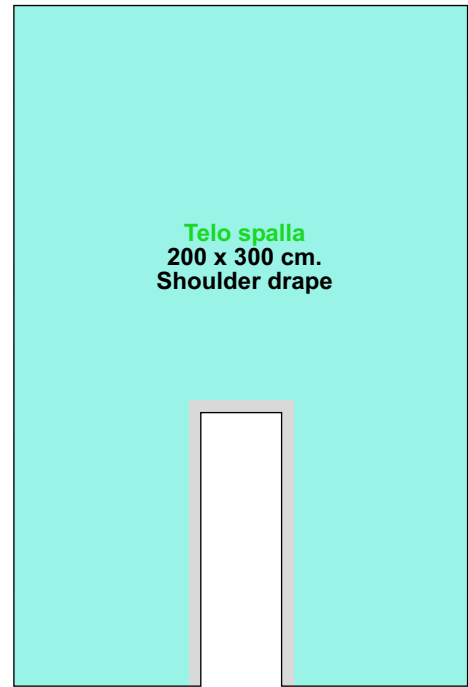

Contenuto - Content	Size (Cm.)	Qt./Piece
Telo anca Hip U drape	200x300	1
Telo anestesia con adesivo Drape with adhesive type	200x300	1
Telo gamba con lato adesivo Leg drape with adhesive type	150x180	1
Telo per tavolo strumenti Tools table drape	100x150	1
Telo di mayo per tavolo Mayo table drape	80x150	1
Camice chirurgico rinforzato Standard surgery gown	Large	2
Salvietta Towel	40x40	2
Confezione di sterilizzazione Pack of sterilization	100x100	1

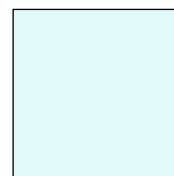
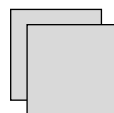
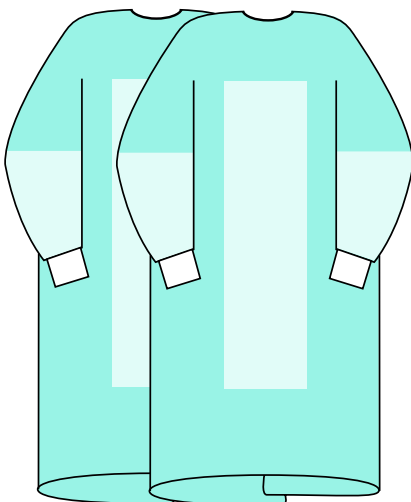
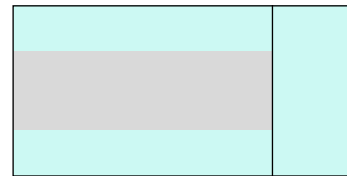
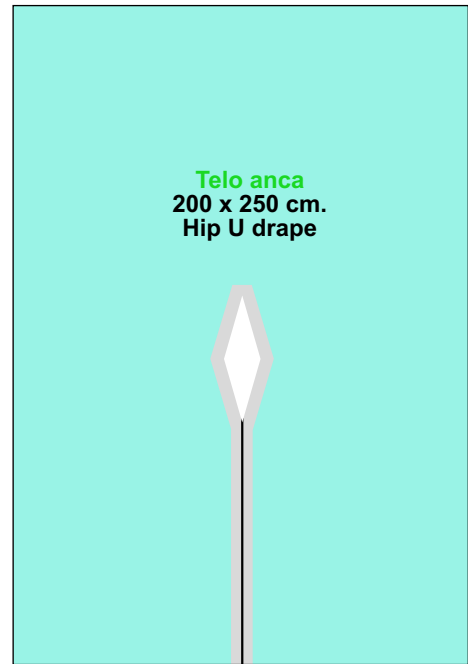

Contenuto - Content	Size (Cm.)	Qt./Piece
Telo E.N.T. Split E.N.T. drape	150x200	1
Telo Drape	100x100	1
Telo per tavolo strumenti Tools table drape	100x150	1
Cerotto Op - tape	10x30	2
Camice chirurgico standard Standard surgery gown	Large	2
Salvietta Towel	40x40	2
Confezione di sterilizzazione Pack of sterilization	100x100	1

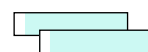
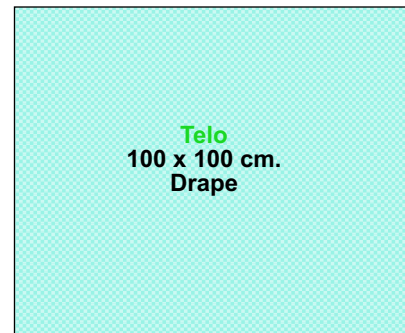

Cerotto
10 x 30 cm.
Op - tape

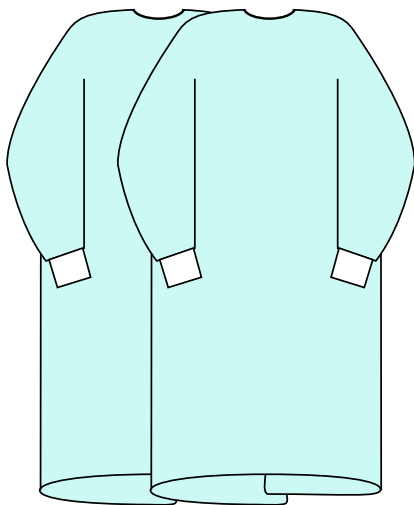

Camice chirurgico standard
Large
Standard surgery gown

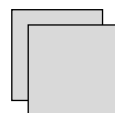

Salvietta
40 x 40 cm.
Towel

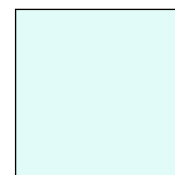

Confezione di
sterilizzazione
100 x 100 cm.
Pack of sterilizaion



Contenuto - Content	Size (Cm.)	Qt./Piece
Telo tiroide Thyroid drape	200x240	1
Telo per tavolo strumenti Tools table drape	100x150	1
Cerotto Op - tape	10x30	2
Camice chirurgico standard Standard surgery gown	Large	2
Salvietta Towel	40x40	2
Confezione di sterilizzazione Pack of sterilization	100x100	1

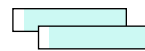

Cerotto
10 x 30 cm.
Op - tape

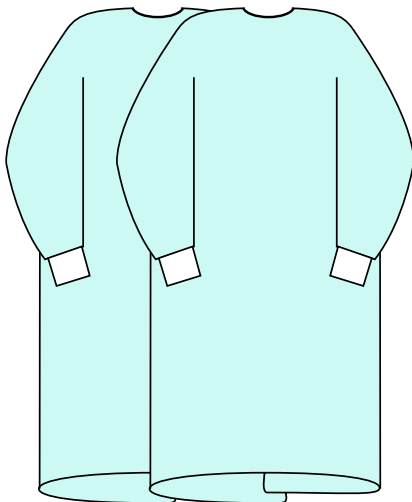

Camice chirurgico standard
Large
Standard surgery gown

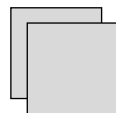

Salvietta
40 x 40 cm.
Towel



Confezione di sterilizzazione
100 x 100 cm.
Pack of sterilization



Set chirurgico vertebra - Vertebra drape set

Contenuto - Content	Size (Cm.)	Qt./Piece
Telo per anestesia Anesthesia drape	150x200	1
Telo gamba Leg drape	150x180	1
Telo per tavolo strumenti Tools table drape	150x200	1
Telo di mayo per tavolo Mayo table drape	80x150	1
Telo con lato adesivo Drape with adhesive tape	100x120	2
Telo con lato adesivo Drape with adhesive tape	75x100	2
Cerotto Op- tape	10x30	2
Matita dermatografica e righello Marker and ruller		1
Camice chirurgico standard Standard surgery gown	Large	2
Sacca universale Universal bag	50x60	2
Salvietta Towel	40x40	2
Confezione di sterilizzazione Pack of sterilization	100x100	1

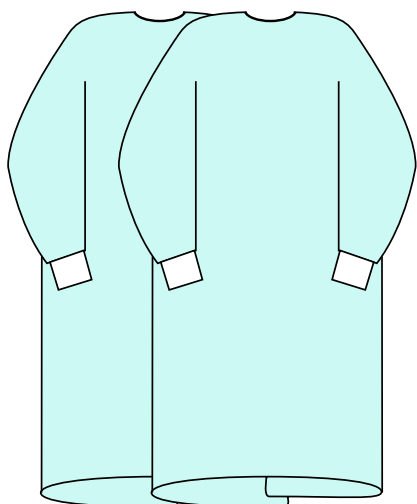
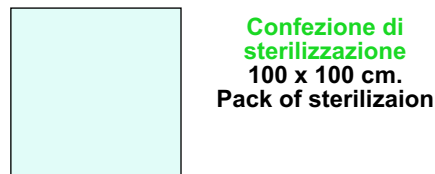
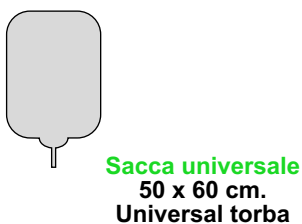
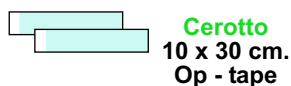
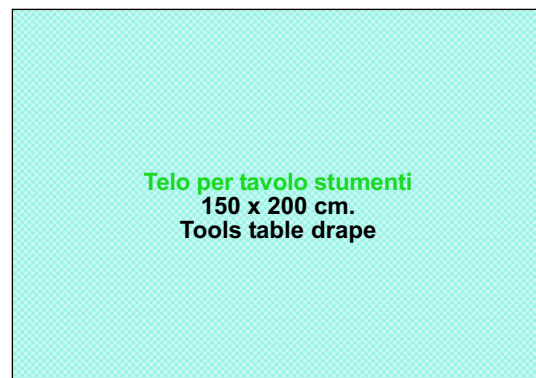
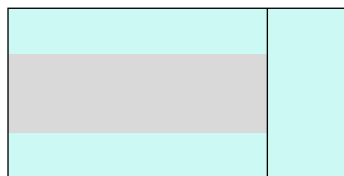
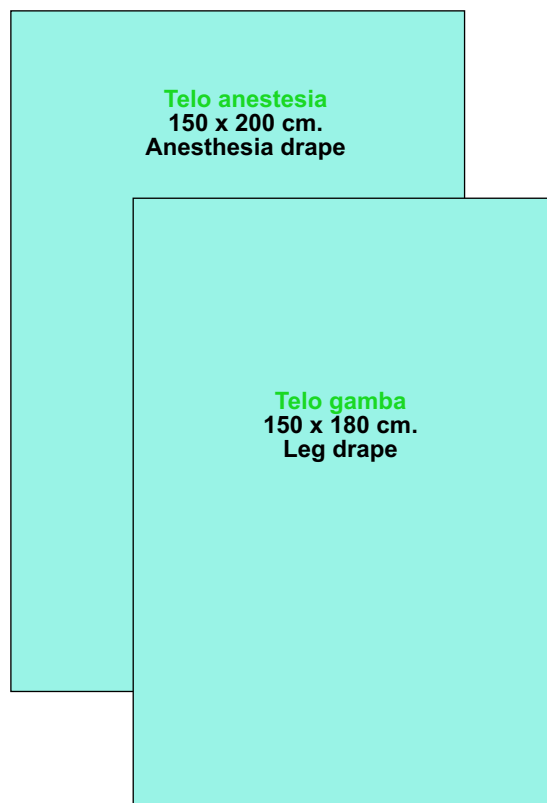

Set chirurgia Cardiologia / Cardiology surgery drape sets



Set chirurgia Estetica / Aesthetic surgery drape sets



Contenuto - Content	Size (Cm.)	Qt./Piece
Telo rinoplastica Rhinoplasty drape	150x250	1
Telo per tavolo strumenti Tools table drape	75x100	2
Telo di mayo per tavolo Mayo table drape	80x150	1
Camice chirurgico standard Standard surgery gown	Large	1
Salvietta Towel	40x40	1
Confezione di sterilizzazione Pack of sterilization	75x75	1

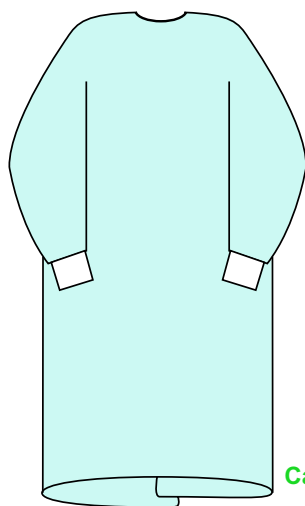
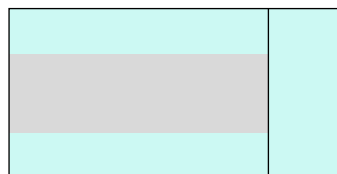
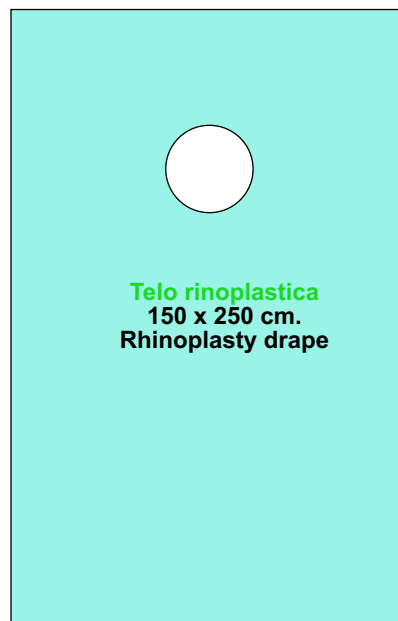

18 Set chirurgico angiografia - Angiography drape set

Contenuto - Content	Size (Cm.)	Qt./Piec
Telo angiografia Angiography drape	150x240	1
Telo per tavolo strumenti Tools table drape	100x150	1
Tamponi Spanch	7,5x7,5	10
Contenitore per soluzione Solution cup	500 cc.	1
Copertura per fluoroscopia Fluroscopy cover	85x85	1
Camice chirurgico standard Standard surgery gown	Large	2
Salvietta Towel	40x40	2
Confezione di sterilizzazione Pack of sterilization	100x100	1

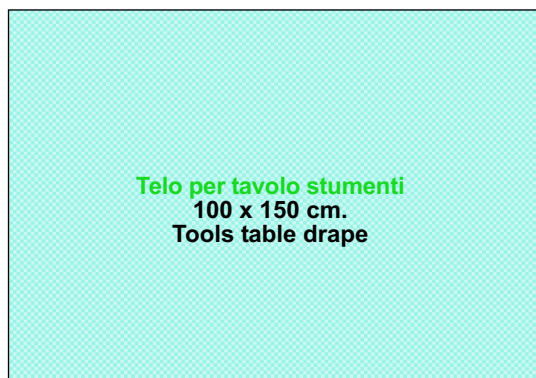
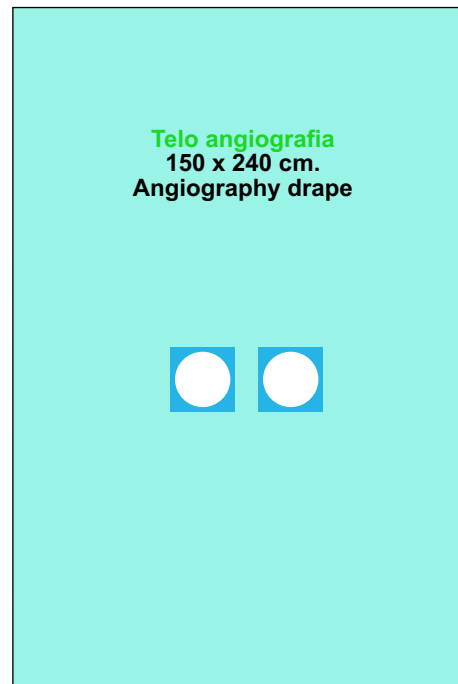

**Contenitore per soluzione
500 cc.
Solution cup**



**Copertura per fluoroscopia
85 x 85 cm.
Fluroscopy cover**

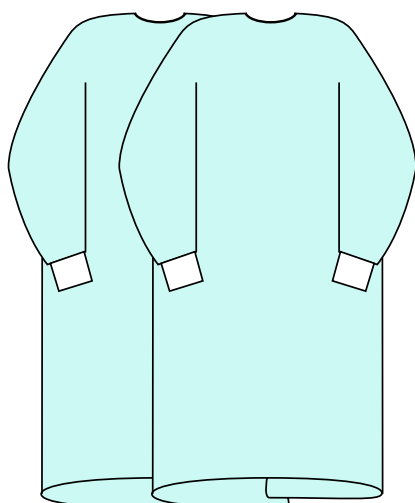

**Camice chirurgico standard
Large
Standard surgery gown**

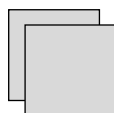

**Salvietta
40 x 40 cm.
Towel**



**Tampone
7,5 x 7,5 cm.
Spanch**



**Confezione di
sterilizzazione
100 x 100 cm.
Pack of sterilizaion**



Contenuto - Content	Size (Cm.)	Qt./Piece
Telo K.V.C. K.V.C. drape	240x350	1
Telo perone U Perine U drape	150x240	1
Telo per tavolo strumenti Tools table drape	150x200	1
Telo di mayo per tavolo Mayo table drape	80x150	1
Stockinite Stockinite	40x60	2
????? Leggins	Standart	2
Cerotto Op - tape	10x30	2
Sacca universale Universal torba	30x35	2
Camice chirurgico rinforzato Reinforced surgery gown	Large	2
Salvietta Towel	40x40	2
Confezione di sterilizzazione Pack of sterilization	100x100	1

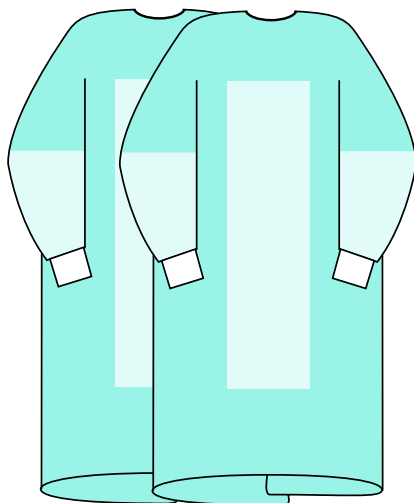
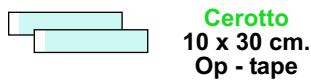
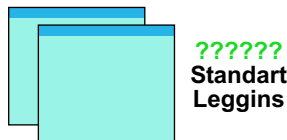
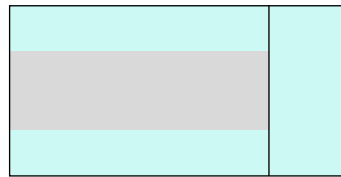
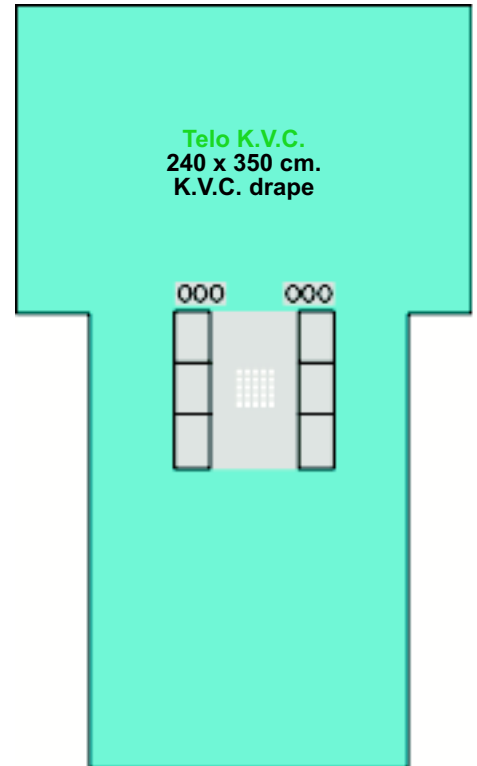

Contenuto - Content	Size (Cm.)	Qt./Piece
Telo per anestesia Anesthesia drape	200x250	3
Telo inferiore paziente Patient sub drape	150x200	1
Cprigambe Leg cover	Standard	2
Telo per tavolo strumenti Tools table drape	100x150	1
Telo di mayo per tavolo Mayo table drape	80x150	1
Camice chirurgico standard Standard surgery gown	Large	2
Salvietta Towel	40x40	2
Confezione di sterilizzazione Pack of sterilization	75x75	1

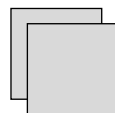
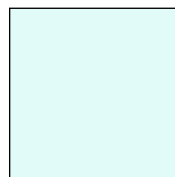
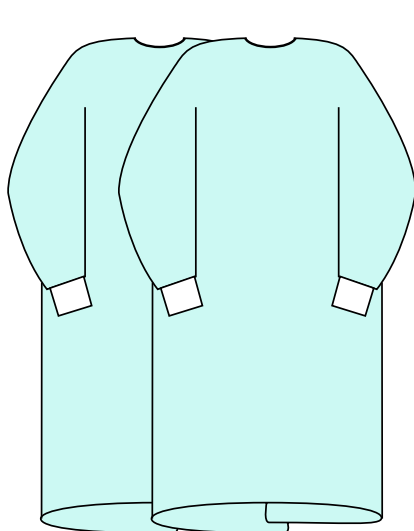
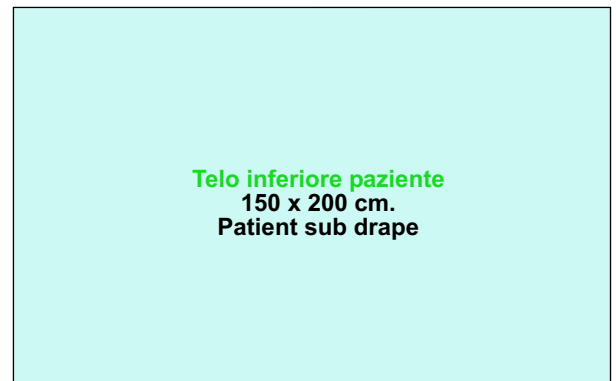
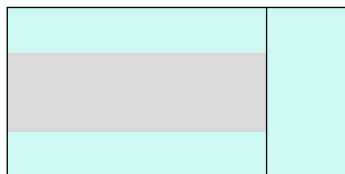
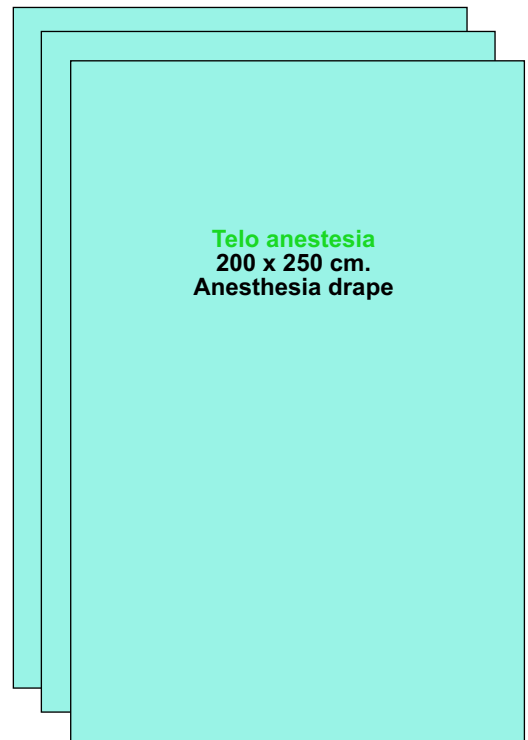

Contenuto - Content	Size (Cm.)	Qt./Piece
Telo Drape	100x150	2
Telo trasparente Transparent drape	30x30	1
Telo per tavolo strumenti Tools table drape	100x150	2

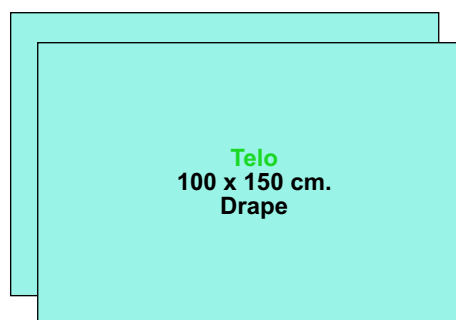

20 Set chirurgico sostituzione valvola - Valve replacement

Contenuto - Content	Size (Cm.)	Qt./Piece
Telo K.V.C. K.V.C. drape	240x350	1
Telo per tavolo strumenti Tools table drape	150x200	1
Telo di mayo per tavolo Mayo table drape	80x150	1
Cerotto Op-tape	10x30	2
Sacca universale Universal torba	30x35	2
Camice chirurgico rinforzato Reinfoced surgery gown	Large	2
Salvietta Towel	40x40	2
Confezione di sterilizzazione Pack of sterilization	100x100	1

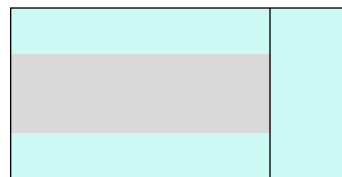
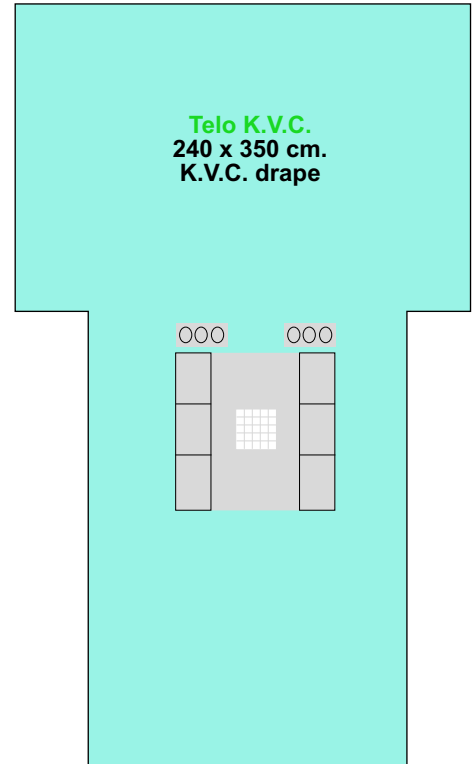

Sacca universale
30 x 35 cm.
Universal torba

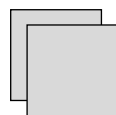
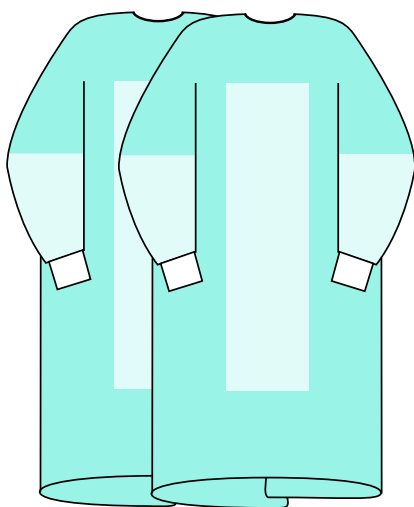

Salvietta
40 x 40 cm.
Towel

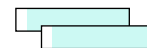

Cerotto
10 x 30 cm.
Op - tape



Confezione di
sterilizzazione
100 x 100 cm.
Pack of sterilizaion



Contenuto - Content	Size (Cm.)	Qt./Piece
Telo con lato adesivo Drape with adhesive	200x150	1
Telo con lato adesivo Drape with adhesive	100x100	1
Telo con lato adesivo Drape with adhesive	50x90	1
Telo per tavolo strumenti Tools table drape	150x200	1
Telo di mayo per tavolo Mayo table drape	80x150	1
Camice chirurgico rinforzato Standard surgery gown	Large	2
Salvietta Towel	40x40	2
Confezione di sterilizzazione Pack of sterilization	100x100	1

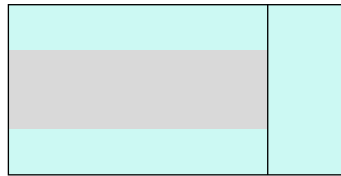

Telo di mayo per tavolo
80 x 150 cm.
Mayo table drape

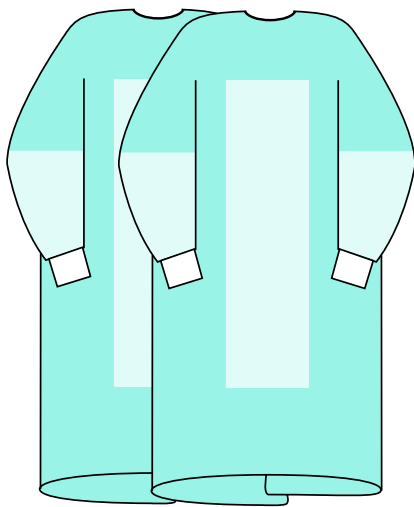

Camice chirurgico rinforzato
Large
Reinforced surgery gown

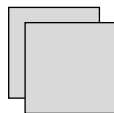

Salvietta
40 x 40 cm.
Towel

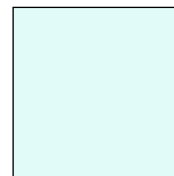

Confezione di sterilizzazione
100 x 100 cm.
Pack of sterilization



Set chirurgia Dentale / Dental surgery drape sets



Contenuto - Content	Size (Cm.)	Qt./Piece
Telo foro bocca paziente Patient mouth hole drape	150x150	1
Telo con adesivo Drape with adhesive tape	150x150	1
Telo per tavolo strumenti Tools table drape	80x150	1
Copri tubo trasparente Transparent hose cover	8x200	3
Camice chirurgico standard Standard surgery gown	Large	1
Salvietta Towel	40x40	1
Confezione di sterilizzazione Pack of sterilization	100x100	1

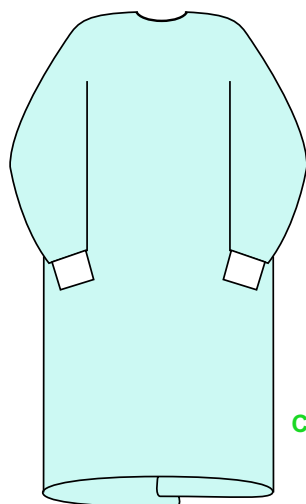
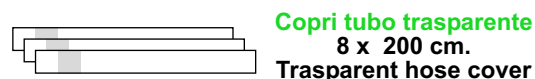
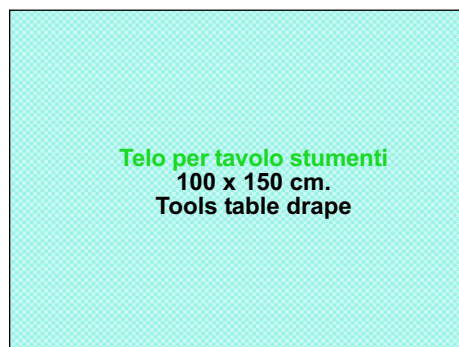
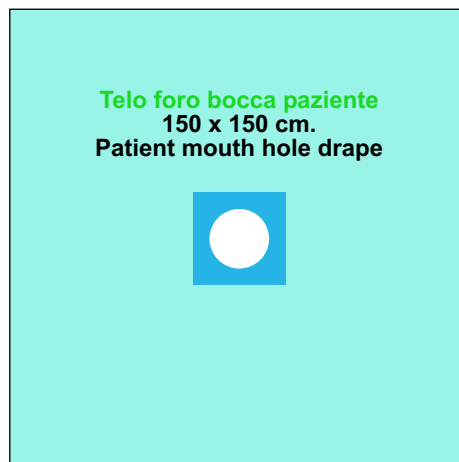

Set chirurgia Ginecologica / Gynecology surgery drape sets



Contenuto - Content	Size (Cm.)	Qt./Piece
Telo con foro e lato adesivo Hole drape with adhesive tape	50x90	1
Telo Drape	80x80	1
Tampone Spanch	7,5x7,5	10
Camice chirurgico standard Standard surgery gown	Large	2
Salvietta Towel	40x40	2
Confezione di sterilizzazione Pack of sterilization	100x100	1

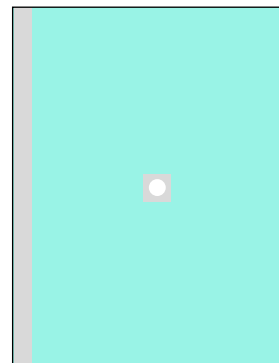

Telo forato con lato adesivo
50 x 90 cm.
Hole drape with adhesive tape

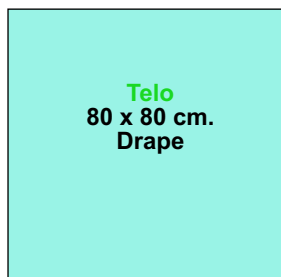

Telo
80 x 80 cm.
Drape



Tampone
7,5 x 7,5 cm.
Spanch

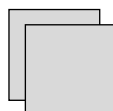

Salvietta
40 x 40 cm.
Towel

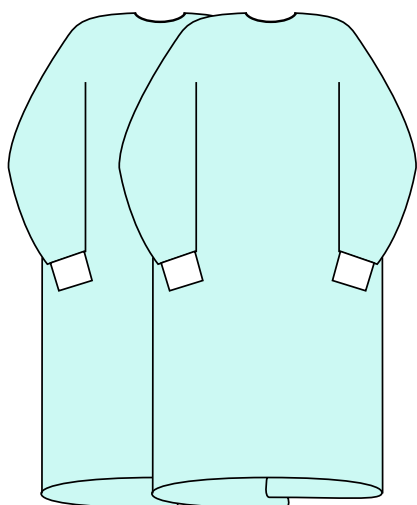

Camice chirurgico standard
Large
Standard surgery gown

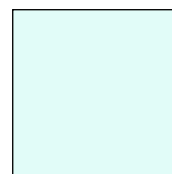

Confezione di
sterilizzazione
100 x 100 cm.
Pack of sterilizaion



Contenuto - Content	Size (Cm.)	Qt./Piece
Telo piastra Plate drape	50x50	1
Telo per tavolo strumenti Tools table drape	50x50	1
Tampone Spanch	7,5x7,5	10
Telo trasparente Transparent drape	10x200	2
Telo riflettente Reflector drape	15x15	2
Camice chirurgico standard Standard surgery gown	Large	1
Salvietta Towel	40x40	1
Confezione di sterilizzazione Pack of sterilization	50x50	1

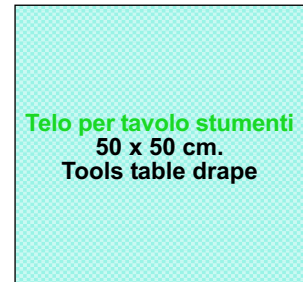

Telo per tavolo stumenti
50 x 50 cm.
Tools table drape



Telo piastra
50 x 50 cm.
Plate drape

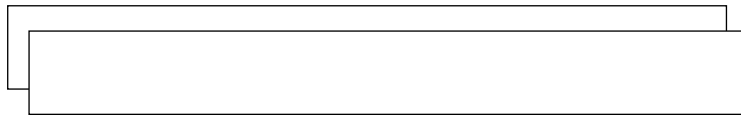

Telo trasparente
10 x 200 cm.
Transparent drape

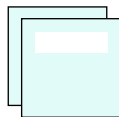

Telo riflettente
15 x 15 cm.
Reflector drape



Tampone
7,5 x 7,5 cm.
Spanch

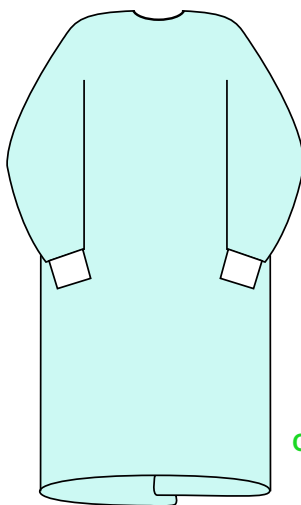

Camice chirurgico standard
Large
Standard surgery gown



Salvietta
40 x 40 cm.
Towel

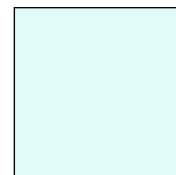

Confezione di
sterilizzazione
50 x 50 cm.
Pack of sterilizaion



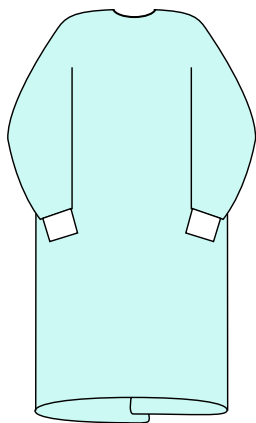

Camice chirurgico standard
Standard surgery gown

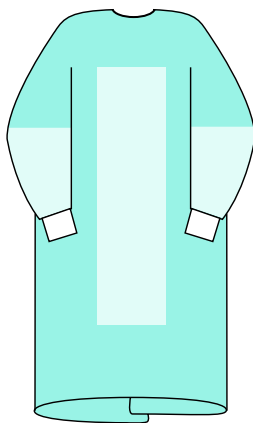

Camice chirurgico rinforzato
Reinforced surgery gown

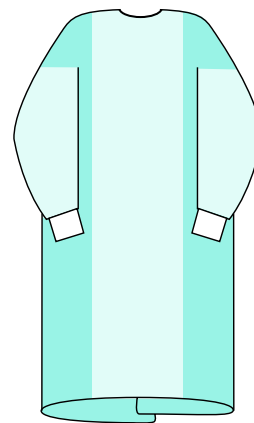

Camice chirurgico completamente rinforzato
Full reinforced surgery gown

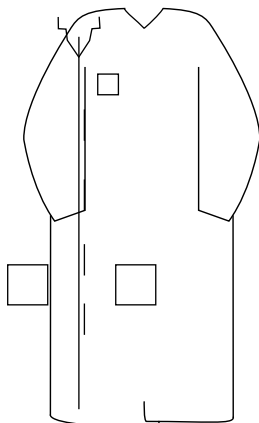

Camice visitatore
Visitor gown

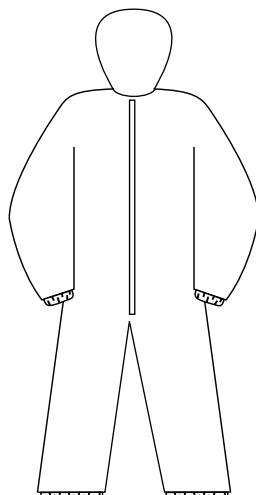

Tuta
Coverall

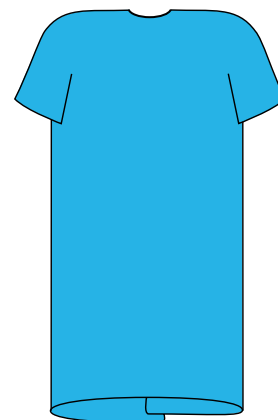

Camice per esame paziente
Patient examination gown

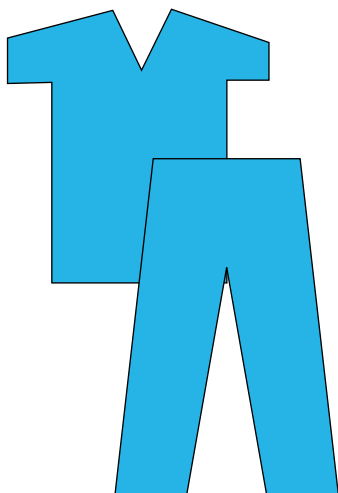

Maglietta e pantaloni
Shirt and pants

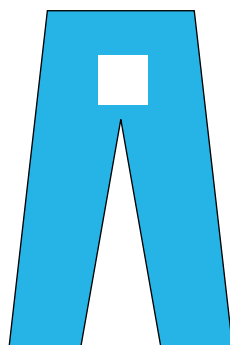

Pantaloni colonoscopia
Colonoscopy pants

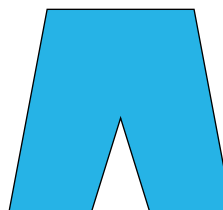

Pantaloncini
Shorts



Ciabatte usa e getta
Disposable slippers



Contenuto - Content	Size (Cm.)	Qt./Piec
Telo I.V.F. I.V.F. drape	150x225	1
Telo per tavolo strumenti Tools table drape	100x150	1
Copri gambe Leg cover	50x120	2
Tampone Spanch	7,5x7,5	10
Copertura per videocamera Video camera cover	13x250	1
Sacca universale Universal bag	50x60	1
Camice chirurgico standard Standard surgery gown	Large	2
Salvietta Towel	40x40	2
Confezione di sterilizzazione Pack of sterilization	100x100	1

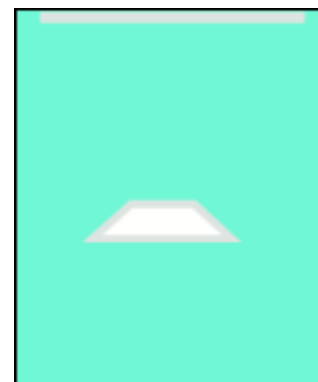

Telo I.V.F.
150 x 225 cm.
I.V.F. drape



Telo per tavolo stumenti
100 x 150 cm.
Tools table drape



Tamponi
7,5 x 7,5 cm.
Spanch



Coprigambe
50 x 120 cm.
Leg cover

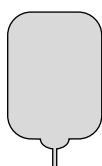

Sacca universale
50 x 60 cm.
Universal torba



Copertura per videocamera
13 x 250 cm.
Video camera cover

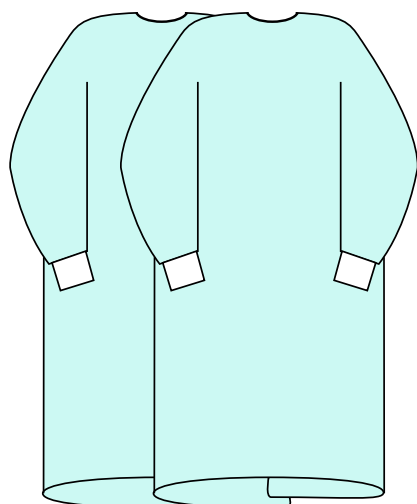

Camice chirurgico standard
Large
Standard surgery gown

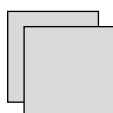

Salvietta
40 x 40 cm.
Towel

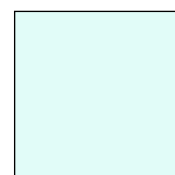

Confezione di
sterilizzazione
100 x 100 cm.
Pack of sterilizaion



Contenuto - Content	Size (Cm.)	Qt./Piece
Telo forato con lato adesivo Hole drape with adhesive tape	75x150	1
Telo neonato Baby drape	75x75	1
Telo per tavolo strumenti Tools table drape	100x150	1
Coprigambe Leg cover	80x120	2
Camice chirurgico rinforzato Reinforced surgery gown	Large	2
Salvietta Towel	40x40	2
Confezione di sterilizzazione Pack of sterilization	100x100	1

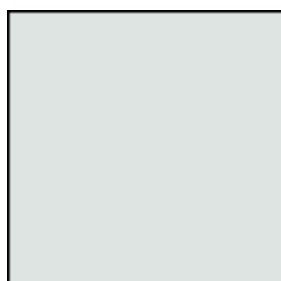
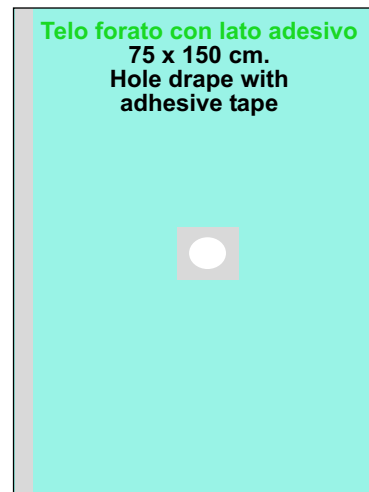

Telo neonato
75 x 75 cm.
Baby drape



Telo
75x 100 cm.
Drape



Telo per tavolo stumenti
100 x 150 cm.
Tools table drape



Coprigambe
60 x 120 cm.
Leg cover

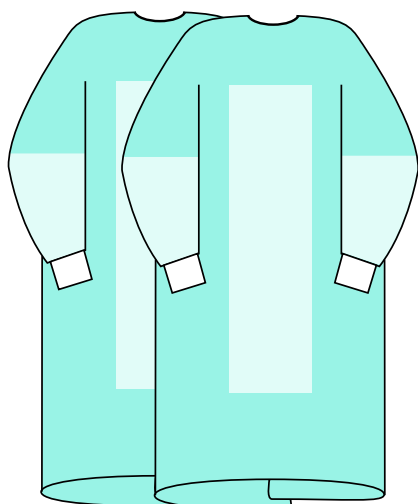

Camice chirurgico rinforzato
Large
Reinforced surgery gown

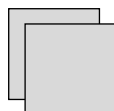

Salvietta
40 x 40 cm.
Towel

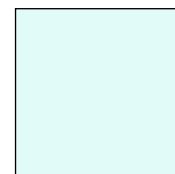

Confezione di
sterilizzazione
100 x 100 cm.
Pack of sterilizaion





Contenuto - Content	Size (Cm.)	Qt./Piece
Telo cesario Cesarean drape	250x300	1
Telo per tavolo strumenti Tools table drape	100x150	1
Telo neonato Baby drape	75x75	1
Camice chirurgico rinforzato Standard surgery gown	Large	2
Salvietta Towel	40x40	2
Confezione di sterilizzazione Pack of sterilization	100x100	1

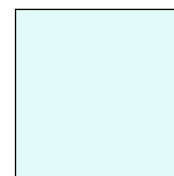
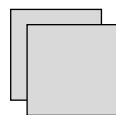
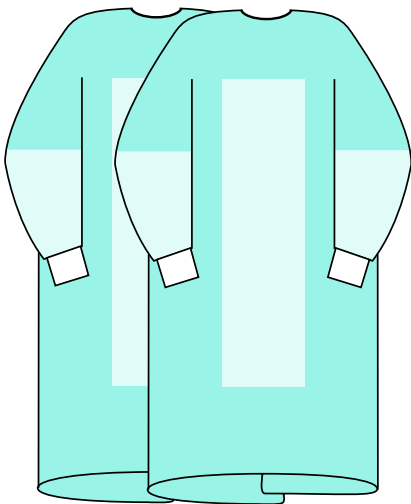
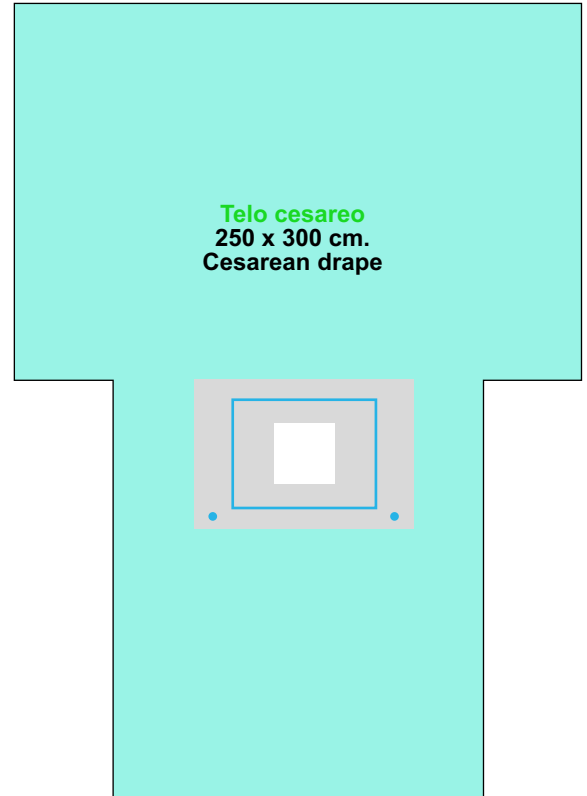

Set chirurgia O.P.U. - O.P.U. drape set

Contenuto - Content	Size (Cm.)	Qt./Piece
Telo O.P.U. O.P.U. drape	130x150	1
Telo Drape	75x100	1
Telo trasparente Transparent drape	60x60	1
Telo per tavolo strumenti Tools table drape	100x150	1
Coprigambe Leg cover	60x115	1
Camice chirurgico standard Standard surgery gown	Large	2
Salvietta Towel	40x40	2
Confezione di sterilizzazione Pack of sterilization	100x100	1

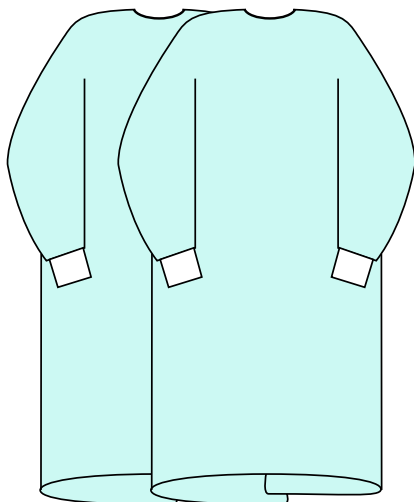
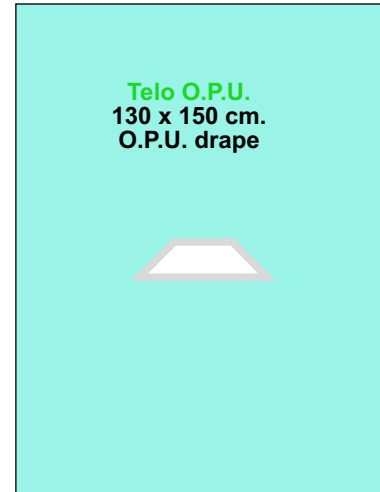

Camice chirurgico standard
Large
Standard surgery gown

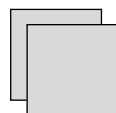

Salvietta
40 x 40 cm.
Towel



Coprigamba
60 x 115 cm.
Leg cover

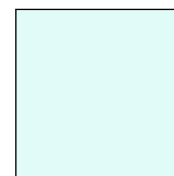

Confezione di
sterilizzazione
100 x 100 cm.
Pack of sterilizaion





Set chirurgia Neurologica / Brain surgery drape sets



Set chirurgia craniotomia - Craniotomy drape set

Contenuto - Content	Size (Cm.)	Qt./Piece
Telo craniotomia Craniotomi drape	230x300	1
Telo di mayo per tavolo Mayo table drape	80x150	1
Cerotto Op - tape	10x50	1
Telo con adesivo Drape with adhesive tape	50x50	4
Telo per tavolo strumenti Tools tabledrape	150x200	1
Camice chirurgico rinforzato Reinforced surgery gown	Large	2
Salvietta Towel	40x40	2
Confezione di sterilizzazione Pack of sterilization	100x100	1

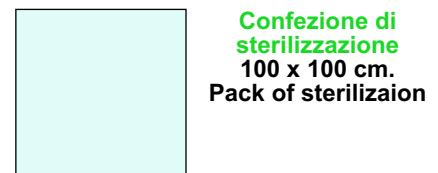
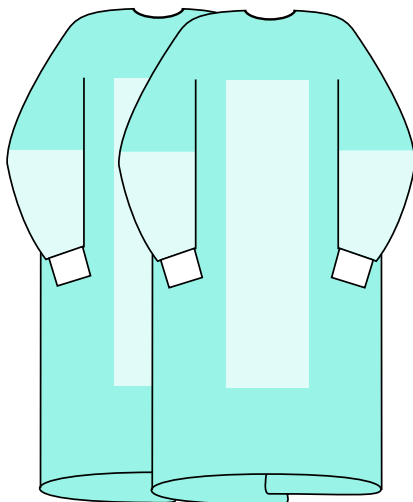
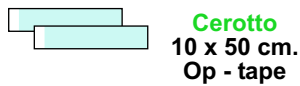
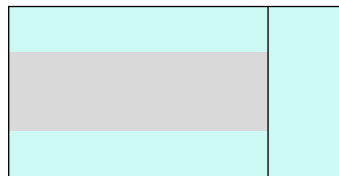
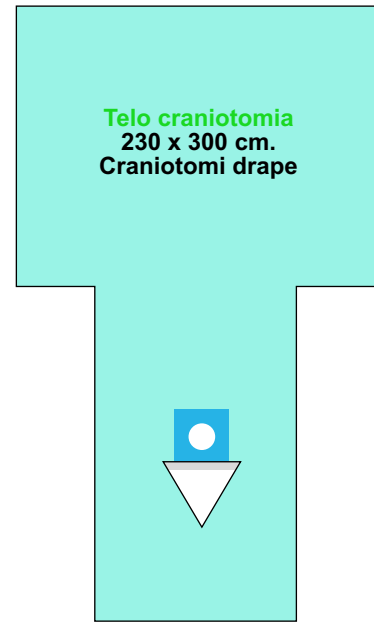

Malamo s.r.l.
Via Cornarotta, 4
32032 Feltre - Belluno
ITALIA

Malamo I.t.d.
Ave Tseteteli, 112
0119 Tbilisi
GEORGIA

Contatti:

Uff. import / export
Uff. marketing
Uff. finanze

impex@igigroup.org
marketing@igigroup.org
fin@malamo.org

Commerciale Italia

Fabrizio Perletto
Via Antica Romana, 7 - int. 1
17026 - Noli (SU)
Tel. / Fax. +39 019 748041
Mobile +39 335 376668
E-mail - fabrizio.perletto@virgilio.it

Set chirurgico shunt - Shunt drape set

Contenuto - Content	Size (Cm.)	Qt./Piece
Telo shunt Shunt drape	150x300	1
Telo per tavolo strumenti Tools table drape	150x200	1
Telo di mayo per tavolo Mayo table drape	80x150	1
Telo con lato adesivo Side drape with adhesive tape	100x120	2
Camice chirurgico rinforzato Standard surgery gown	Large	1
Salvietta Towel	40x40	2
Confezione di sterilizzazione Pack of sterilization	100x100	1

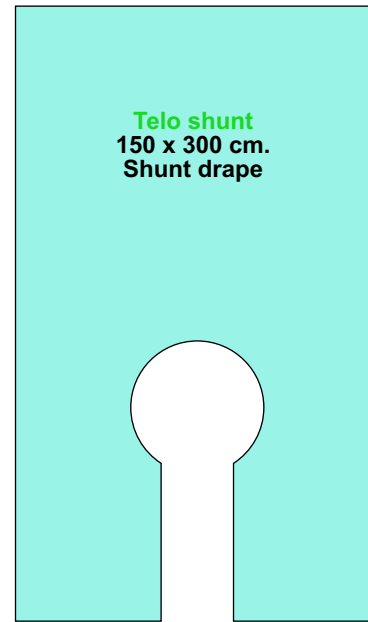

Telo shunt
150 x 300 cm.
Shunt drape



Telo per tavolo stumenti
150 x 200 cm.
Tools table drape



Telo con lato adesivo
100 x 120 cm.
Side taped drape

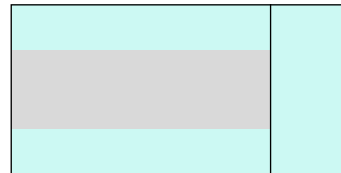

Telo di mayo per tavolo
80 x 150 cm.
Mayo table drape

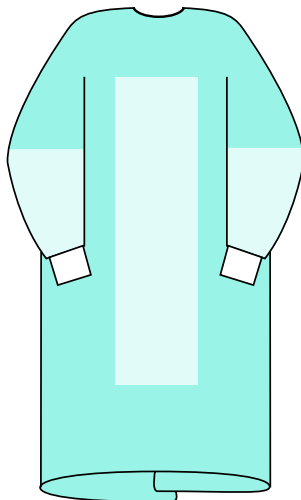

Camice chirurgico rinforzato
Large
Reinforced surgery gown

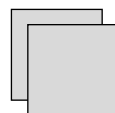

Salvietta
40 x 40 cm.
Towel

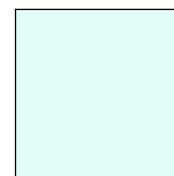

Confezione di sterilizzazione
100 x 100 cm.
Pack of sterilization



Contenuto - Content	Size (Cm.)	Qt./Piece
Telo spinale Spinal drape	200x300	1
Telo per tavolo strumenti Tools table drape	150x200	1
Telo di mayo per tavolo Mayo table drape	80x150	1
Telo con lato adesivo Side taped drape	100x120	2
Cerotto Op - tape	10x50	2
Matita dermatografica e righello Marker and ruler		1
Sacca universale Universal bag	50x60	1
Camice chirurgico rinforzato Reinforced surgery gown	Large	3
Salvietta Towel	40x40	3
Confezione di sterilizzazione Pack of sterilization	100x100	1

